

ViewScape Toolset



User Guide

Product revision

Software version: 1.1

Barco nv Events

Noordlaan 5, B-8520 Kuurne

Phone: +32 56.36.89.70

Fax: +32 56.36.88.24

E-mail: events@barco.com

Visit us at the web: www.barco.com

Printed in Belgium

Copyright ©

All rights reserved. No part of this document may be copied, reproduced or translated. It shall not otherwise be recorded, transmitted or stored in a retrieval system without the prior written consent of Barco.

Trademarks

Brand and product names mentioned in this manual may be trademarks, registered trademarks or copyrights of their respective holders. All brand and product names mentioned in this manual serve as comments or examples and are not to be understood as advertising for the products or their manufactures.

Software Licence Agreement

User agreement for ViewScape Toolset Software

IMPORTANT: This Software Agreement is a legal agreement between the end user and the producer of the software product identified above, which includes computer software and associated media and printed materials, and includes "online" or electronic documentation. By installing, copying, or otherwise using the SOFTWARE PRODUCT, you agree to be bound by the terms of this Agreement.

The SOFTWARE PRODUCT is protected by copyright laws and international copyright treaties, as well as other intellectual property laws and treaties.

Systems Software - You may install and use this SOFTWARE PRODUCT only in conjunction with other Barco products where it is made for.

If you have acquired this software with the purchase of a product you may make a number of additional copies of the computer software portion of the SOFTWARE PRODUCT only for authorized training off line for a Barco System.

RIGHTS AND LIMITATIONS. You may not reverse engineer, decompile, or disassemble the SOFTWARE PRODUCT.

NO LIABILITY FOR CONSEQUENTIAL DAMAGES To the maximum extent permitted by applicable law, in no event shall the manufacturer or it's suppliers be liable for any special, incidental, indirect, or consequential damages whatsoever (including, without limitation, damages for loss of business profits, business interruption, loss of business information, or any other pecuniary loss) arising out of the use of or inability to use the software product, even if the manufacturer has been advised of the possibility of such damages.

TABLE OF CONTENTS

1. Introduction	5
1.1 General introduction	5
2. Installation	7
2.1 General Requirements	7
2.2 Software installation	7
2.3 Starting up	9
2.4 Closing	11
3. Configuration Wizard	13
3.1 The wizard window	13
3.2 Set up paths	13
3.3 Creating a new configuration	14
3.3.1 Based on ViewScape devices	14
3.3.1.1 Getting started	14
3.3.1.2 Set up	15
3.3.2 Based on the output requirements (resolution)	17
3.3.2.1 Getting started	17
3.3.2.2 Set up	18
3.3.3 Creating a configuration starting from last saved file	19
3.3.4 Current Configuration	19
3.3.5 Digitizer output selection	20
3.3.6 Defining the working windows	21
3.3.7 Removing windows out of the list	22
3.3.8 Configuration preview	22
3.3.9 Autodetection of connected devices	23
3.3.9.1 RS232 Communication Settings	23
3.3.9.2 Start Autodetection	25
3.3.9.3 Serial Numbers	26
3.3.10 Compare Autodetected configuration – Created configuration	27
3.3.11 Updating the configuration	28
3.3.12 Output check	29
3.3.13 Mechanical overlap setup	32
3.3.14 Input Balance Adjustment	34
3.3.15 Gamma setup – Soft edge blending	34
3.3.16 Contrast and Color equalization	35
3.3.17 Black level Adjustment of the images	36
3.3.18 Loading final settings	37
3.3.19 Finishing the wizard	38
3.4 Loading a saved configuration	39
4. The ViewScape application	41
4.1 Menu structure overview	41
4.2 Display selection	42
5. RS232 Set up	43
5.1 Start up	43
5.2 Quick status change of RS232	44
6. Autodetect page	45
6.1 Start up of the Autodetect page	45
6.2 Actions on the Autodetection page	46
7. Windowing	47
7.1 Input and Display configuration	47
7.2 Selecting a Window	48
7.3 Moving a window	48
7.4 Scaling Windows	49

Table of contents

7.5	Making group changes to a window	50
7.6	Z-Order	50
7.7	Aspect Ratio	52
7.8	Changing a window name	52
7.9	Changing the window mode	53
7.10	Locking a window	54
7.11	Creating a full window	54
7.12	ViewPort	55
7.12.1	General	55
7.12.2	Creating a ViewPort for a single source	56
7.12.3	Creating a viewport for a multiple 'independent' (hard edged) background	58
7.12.4	Creating a viewport for a multiple 'overlapped' background	59
7.12.5	Making group changes to the viewport	60
7.12.6	Apply Viewport setting source 1 to source 2	60
7.13	Visibility setup of a source	61
7.14	Color key	62
7.15	Alpha Blending	64
7.16	Settings	66
7.17	Work Space Resolution	66
7.18	Preset Configurations	67
7.18.1	Saving a configuration	67
7.18.2	Loading a configuration, way 1	68
7.18.3	Loading a configuration, way 2	69
7.18.4	Loading a configuration, way 3	70
7.18.5	Removing a predefined configuration	70
8.	Configuration Manager	73
8.1	Overview of the configuration manager	73
8.2	Saving a Configuration	74
8.3	"Save as" a Configuration	75
8.4	Deleting a Configuration	76
8.5	Loading a Configuration	78
9.	Preferences	81
9.1	Purpose of the preferences set up	81
9.2	Start up the preferences	81
9.3	Adjusting the window offset	82
9.4	Changing the Screen position	82
10.	ViewScape Configuration	83
10.1	ViewScape Configuration start up	83
10.2	ViewScape Settings	84
10.2.1	Operational Mode	84
10.2.2	Output Selection	85
10.2.3	Timings	85
10.2.3.1	Using predefined timings for digital or analog output	86
10.2.3.2	Using the advanced timing settings for digital or analog output	86
10.2.3.3	Timings of Sync Generator for Digital or Analog output	88
10.2.3.4	Timings of Display Interface for Digital or Analog output	90
10.2.4	Pattern Generation	91
10.2.4.1	Overview and activation	91
10.2.4.2	Test pattern set up	93
10.2.5	Soft Edge and Black level adjustment	94
10.2.5.1	Overview and activation	94
10.2.5.2	Soft Edge Settings	95
10.2.5.3	Black level adjustment	96
11.	Input Slots for ViewScape	97
11.1	General info	97
11.2	Input D320 DVI-D	98
11.2.1	Settings start up	98

11.2.2 Image Processing	99
11.3 Input D320 YUV/RG(s)B	99
11.3.1 Settings start up	99
11.3.2 Image Processing	100
11.3.3 Input Gain Equalizing	102
11.3.4 Dynamic Image Stabilizer (DIS)	102
11.3.5 Video Equalizing	103
11.4 Input D320 SDI	103
11.4.1 Settings start up	103
11.4.2 Image Processing	104
11.4.3 Dynamic Image Stabilizer (DIS)	105
11.4.4 Video Equalizing	106
11.5 Input D320 HDSDI	106
11.5.1 Settings start up	106
11.5.2 Image Processing	107
11.5.3 Dynamic Image Stabilizer (DIS)	108
11.5.4 Video Equalizing	108
11.6 Input D320 CVBS/S-Vid	109
11.6.1 Settings start up	109
11.6.2 Image Processing	109
11.6.3 Input Gain Equalizing	111
11.6.4 Dynamic Image Stabilizer (DIS)	112
11.6.5 Video Equalizing	112
11.7 Input D320 RGB analog	113
11.7.1 Settings start up	113
11.7.2 Image Processing	113
11.7.3 Resolution Settings	114
11.7.4 RGB Contrast	115
11.7.5 RGB Brightness	115
11.8 Input D320 RGB analog (UXGA)	115
11.8.1 Settings start up	115
11.8.2 Image Processing	116
11.8.3 Resolution Settings	117
11.8.4 RGB Contrast	118
11.8.5 RGB Brightness	118
Glossary	119
Index	121
List of images	125

1. INTRODUCTION

1.1 General introduction

Overview

ViewScape Toolset software has a guided set up menu with clear wiring diagrams for a hardware setup.

The total screen area is represented as a single canvas onto which the input sources can be arranged by a drag and drop operation. Several layouts can be stored as presets and recalled at any point during the show.

Advanced effects control is built in. E.g. :

- View port
- Zoom within a View port.
- Alpha blending, transforming selected inputs into transparent overlays on the screen.
- Chroma keying (color keying)
- Z-order control
- Edge blending

2. INSTALLATION

Overview

- General Requirements
- Software installation
- Starting up
- Closing

2.1 General Requirements

Before you begin

It assumes you are familiar with the Windows operating system at your site.

The CD-ROM in your package contains a Windows-based installation program. You can install the software from the CD-ROM.

System requirements

A minimum configuration of a Pentium II processor, 160 MHz and 128 MB of RAM.

At least 50 MB of disk space. A CD-ROM drive.

The operating system required is a 32 bit Windows version:

- Windows NT 4.0. with service pack 4.0
- Windows 2000
- Windows XP

Microsoft Internet Explorer 5.5 or higher

The screen resolution of the software is 1024*768 for a good working environment.

2.2 Software installation

To install

The process of installing your software involves the following basic steps:

1. Insert the CD-ROM in the CD-ROM drive.
2. Is the AutoPlay active on your PC.
If yes, continue with step 8.
If no, from within the Windows environment go to the Start Menu and right click on Start.
3. Select explorer.
4. Select the CD-ROM Drive.
5. Double click 'setup.exe' file. Follow the instruction of the install shield.
6. Press **Next** to run the installation.
7. Select an installation folder and click on **Next**.

2. Installation

8. For a new installation select 'Typical'.

With 'Typical', everything necessary to run the program will be installed (Tomcat webserver, Java environment variables and plug ins for the applets).

With 'Custom' you have the choice to install only the ViewScape part or only the Java part.

With 'Compact' you can install the components you want. Only recommended for advanced users. (image 2-1)

9. Press **Next** to execute the installation program.

10. Install java component if necessary.

'ViewScape Toolset' item will be added to the program list.

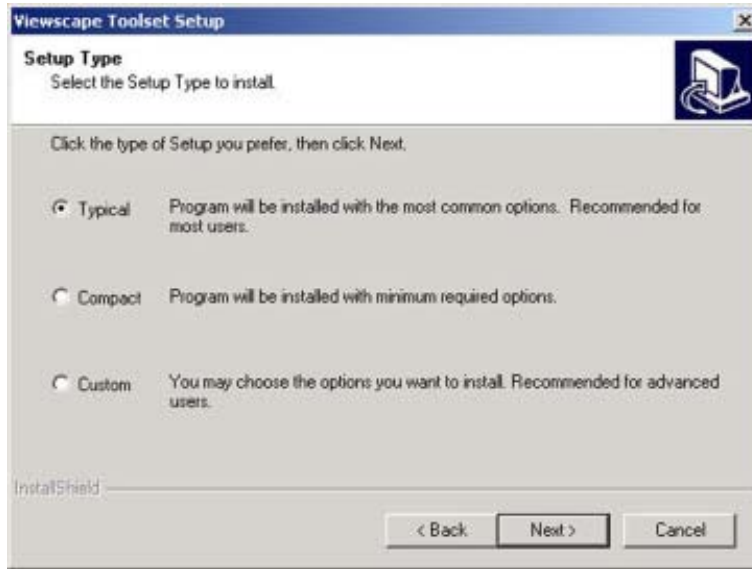

Image 2-1
Set up choices

Check

Some settings of the PC must be checked before launching the software:

1. Check if the Java Virtual machine (VM) is enabled on the PC.
2. Open your Internet Explorer.
Select Tools → Internet Options → Temporary Internet Files → Settings.
3. Check 'Every visit to the page' and press OK. (image 2-2)

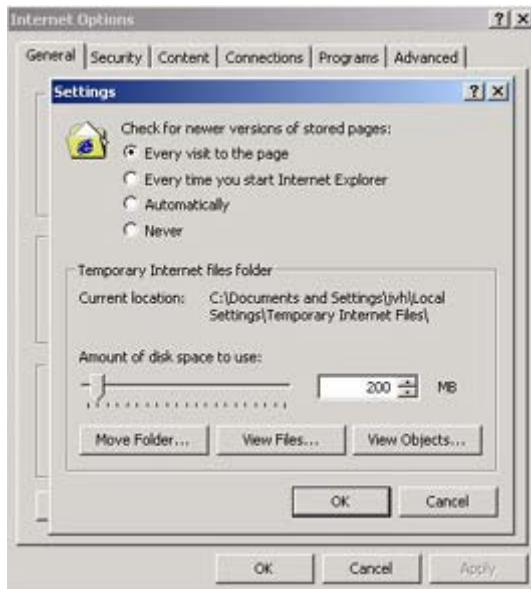

Image 2-2
Internet options Settings

2.3 Starting up

Start up

To start up the ViewScape Toolset software, the following steps are involved:

1. Go to the Start menu, select Programs.
2. Drag your mouse to the right and select 'ViewScape Toolset'.
3. Drag to the right and launch first 'Service Launcher'. (image 2-3)

The service launcher starts up the following processes:

- Tomcat Webserver
- Driver
- Admin engine
- sysid

An icon will be added to the task bar.

4. Go again to Start → Programs → ViewScape Toolset.
5. Drag to the right and launch 'ViewScape Toolset'. (image 2-4)

The ViewScape Toolset will start.

When it is started for the first time, the wizard will be started automatically. (image 2-5)

In all other cases, it will start with the last used configuration. (image 2-6)



Image 2-3
Starting the Service Launcher



Image 2-4
Starting ViewScape Toolset

2. Installation



Image 2-5
Start up of the wizard

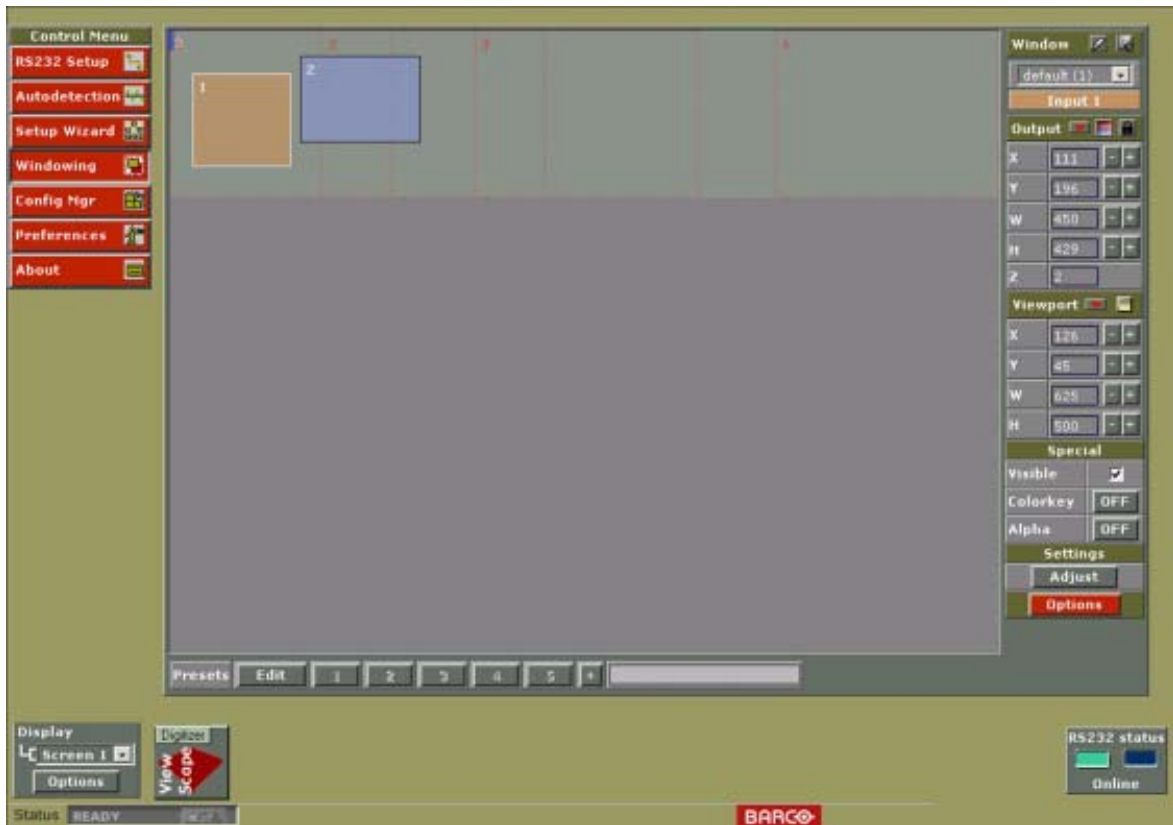

Image 2-6
Start up when configuration known

2.4 Closing

How to close

1. Close the browser always as first by clicking on the browser close button (cross in the right upper corner)
2. Right click on the launcher icon and select *Exit*.

2. *Installation*

3. CONFIGURATION WIZARD

Overview

- The wizard window
- Set up paths
- Creating a new configuration
- Loading a saved configuration

3.1 The wizard window

Purpose

The wizard will guide you through the configuration process of your hardware (ViewScape and projectors).

The window buttons

The following buttons are available in the wizard:



: the wizard goes to the next window.



: the wizard returns to the previous window.



: the wizard gives more info about the items on the active page.



: the wizard will be closed. The user has the choice to save or not to save the configuration settings.

3.2 Set up paths

Overview

The following paths are available to set up a configuration :

- Creating a new configuration based on ViewScape devices or on resolution.
- Starting from an existing file.
- Starting from the last file or last settings.

3.3 Creating a new configuration

Overview

- Based on ViewScape devices
- Based on the output requirements (resolution)
- Creating a configuration starting from last saved file
- Current Configuration
- Digitizer output selection
- Defining the working windows
- Removing windows out of the list
- Configuration preview
- Autodetection of connected devices
- Compare Autodetected configuration – Created configuration
- Updating the configuration
- Output check
- Mechanical overlap setup
- Input Balance Adjustment
- Gamma setup – Soft edge blending
- Contrast and Color equalization
- Black level Adjustment of the images
- Loading final settings
- Finishing the wizard

3.3.1 Based on ViewScape devices

Overview

The configuration will be based on the number of devices (= number of screens in the configuration)

Overview

- Getting started
- Set up

3.3.1.1 Getting started

How to start

1. Select *Create a new configuration*. (image 3-1)
The background of the icon in front of the selection becomes dark green.
2. Click on **Next>>**.
3. Select *based on ViewScape devices*. (image 3-2)
4. Click on **Next>>**.



Image 3-1
Create new configuration



Image 3-2
New configuration based on ViewScape devices

3.3.1.2 Set up

What will be done

During the set up, the screen configuration and resolution should be entered. At the same time a preview with the real width and height will be displayed.

Device set up

1. Click on the drop down box next to *Device setup*. (image 3-3)
2. Select the corresponding configuration. E.g. 4x1, means 4 screens next to each other making up one display.

Possible configurations :

- 1x1
- 2x1
- 3x1
- 4x1
- 5x1
- 6x1
- 7x1
- 8x1
- 9x1
- 10x1

When changing the configuration, the preview and the real dimensions in the lower pane of the window will change accordingly.

3. Configuration Wizard



Image 3-3
Device setup

Resolution per screen

The same resolution for each screen can be set up:

1. Click on the drop down box next to *Resolution per screen*. (image 3-4)
2. Select the resolution, corresponding with the resolution of your display device.

Possible resolutions :

- SVGA
- XGA
- SXGA
- SXGA+
- UXGA

When changing the resolution, the real dimensions in the lower pane preview of the window will change accordingly.

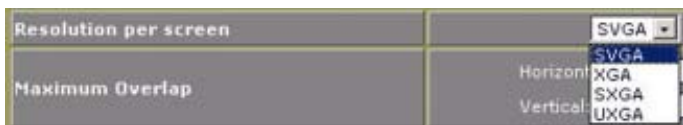

Image 3-4
Resolution per screen

What is overlap area

When projecting two image next to each other a certain area will be common used by the first and the second projector to construct a seamless transition from the left to the right. This area is called the overlap area.

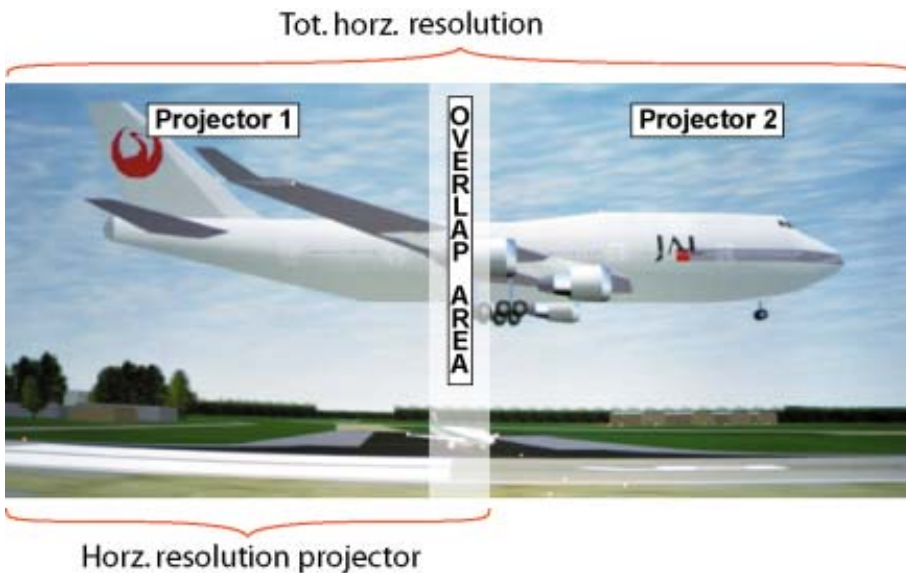

Image 3-5

How to setup

1. Click in the horizontal input field of the maximum overlap for entering an overlap for two images next to each other. (image 3-6)
2. Select with your mouse the actual indicated value.
3. Enter a new value with the keyboard.
The entered value will be de maximum possible overlap.
4. Click in the vertical input field of the maximum overlap for entering an overlap for two images above each other.
5. Select with your mouse the actual indicated value.
6. Enter a new value with the keyboard.
The entered value will be de maximum possible overlap.
7. When finished with the setup, click on **Next>>** to continue the set up (see "Current Configuration", page 19).



Image 3-6
Set up overlap area

3.3.2 Based on the output requirements (resolution)

Overview

- Getting started
- Set up

3.3.2.1 Getting started

How to start

1. Select *Create a new configuration*.
The background of the icon in front of the selection becomes dark green.
2. Click on **Next>>**.
3. Select *based on the output requirements (resolution)*. (image 3-7)
4. Click on **Next>>**.
The design window via requirements will be displayed. (image 3-8)



Image 3-7
Design configuration based on requirements

3. Configuration Wizard

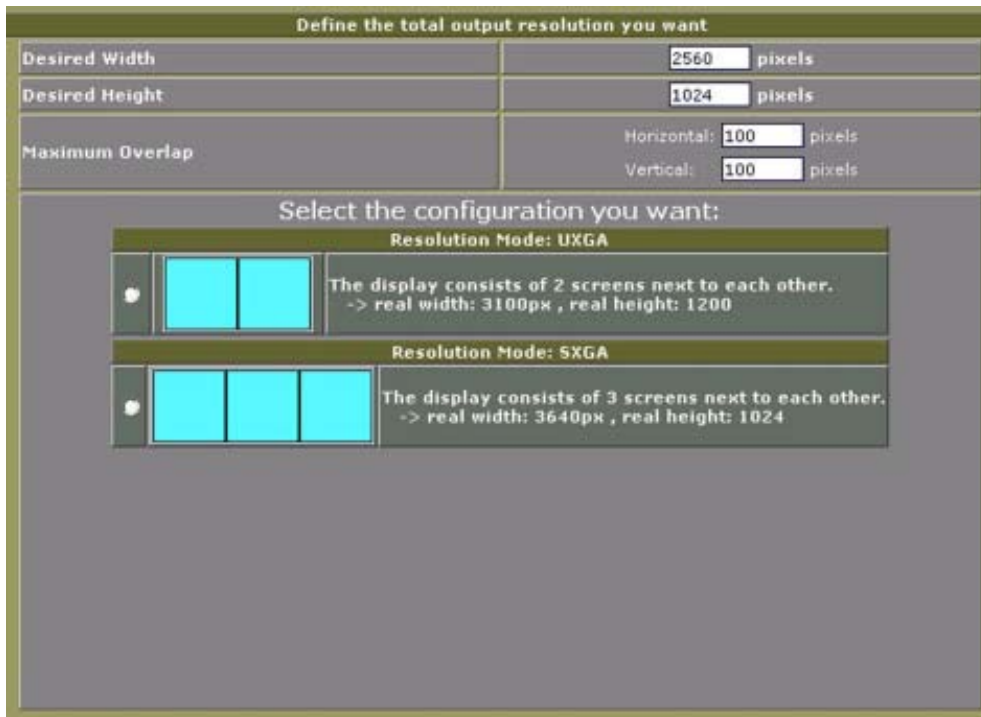

Image 3-8
Resolution definition window

3.3.2.2 Set up

What will be done

The desired screen dimension in pixels should be entered together with the resolution mode. These specifications determine the number of devices required.

Screen Dimensions

1. Click in the input box next to *Desired width*. (image 3-9)
2. Select with your mouse the actual indicated value.
3. Enter a new value with the keyboard. The new value should be resolution of the complete image width
4. Repeat from step 1 for the *Desired Height*.

The possible configuration will be updated on line in the configuration pane of the same window.



Image 3-9
Set up the image dimensions

Overlap area setup

1. Click in the horizontal input field of the maximum overlap for entering an overlap for two images next to each other.
2. Select with your mouse the actual indicated value.
3. Enter a new value with the keyboard.

The entered value will be de maximum possible overlap.

4. Click in the vertical input field of the maximum overlap for entering an overlap for two images above each other.

5. Select with your mouse the actual indicated value.
6. Enter a new value with the keyboard.
The entered value will be de maximum possible overlap.
7. When finished with the setup, click on **Next>>** to continue the set up.

Configuration set up

This pane indicates on line the possible configurations with the real dimensions.

1. Select the radio button in front of the desired configuration. (image 3-10)
2. Click **Next >>** to continue the set up (see "Current Configuration", page 19).

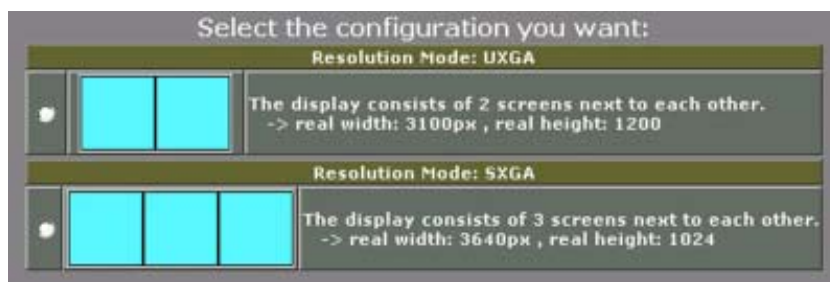

Image 3-10
Configuration selection

3.3.3 Creating a configuration starting from last saved file

What is possible

When a wizard is stopped somewhere in the procedure and the result at that moment was saved, it is possible to restart from that saved file and continue with the wizard. Follow further the instructions of the wizard.

How to start

1. Select *Open last file / start from last settings....* (image 3-11)
2. Click **Next>>** to continue the set up.

The current configuration window opens. Continue with see "Current Configuration", page 19.

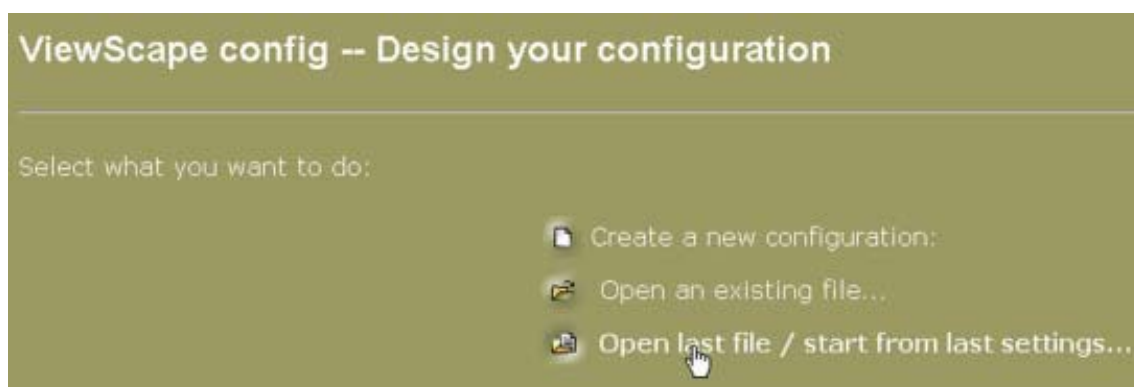

Image 3-11
Starting from last file

3.3.4 Current Configuration

Overview

The current set up gives a small overview of the chosen configuration.

3. Configuration Wizard

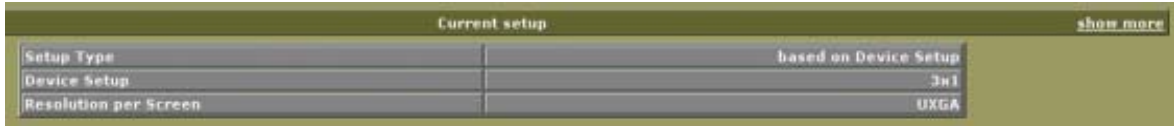

Image 3-12
Current configuration

A small overview gives :

- The setup type
- Device setup
- Resolution per screen

To get a more complete overview, click on *show more* in the header of the current setup pane.



Image 3-13
Detailed current configuration

3.3.5 Digitizer output selection

How to select

1. Click on the drop down box in the Digitizer output pane. (image 3-14)
2. Select the appropriate value.

Analog When the analog output of the ViewScape device is connected to the analog input of the projector.

Digital When the DVI out of the ViewScape device is connected to a DVI input of the projector.

The icon next to the value will change accordingly.

3. Make your choice between manual Refresh-rate set up an Lock to input.

Refresh-rate Manually select the vertical refresh rate between 50Hz and 60Hz by clicking on the drop down box.

Lock to input Select an input of the master ViewScape on which the output must be locked.



Image 3-14
Projector input selection

3.3.6 Defining the working windows

What should be done

The different desired windows and/or background can be defined for each input.

How to define

1. Select a Type (1). (image 3-15)

Possible types:

- CVBS
- DVI
- HDSDI
- RGB
- RGB_UXGA
- SDI
- YUV

2. Click in the *Name* field and enter a name for your source (2).

3. Select the *Mode* (3).

Single normal Source is only be displayed on one single window

Background
multiple Displayed over the complete screen

4. Click on **Add>>**.

The window definition will be added to the list with the entered specifications.

The total number of windows will be indicated on the bottom of the pane.

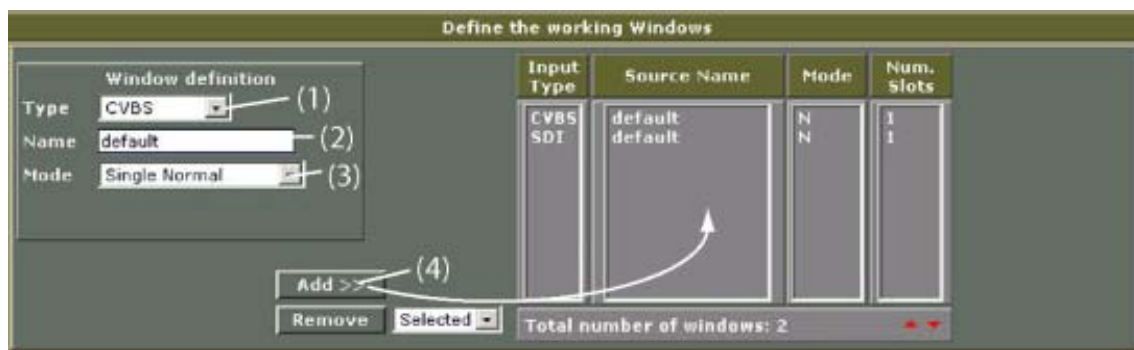

Image 3-15
Defining the working windows



To scroll through the list of windows, use the red arrows on the bottom of the pane.



Do not use RGB sources to compose an multiple background. Due to the signal fall off, it is possible that a vertical line will be visible in the overlap area.

3.3.7 Removing windows out of the list

How to remove

1. Do you want to delete all?
If yes, Select first *All* in the combo box next to remove and then click on **Remove**.
All windows in the list will be deleted.
If no, go to step 2
2. Select first *Selected*.
3. Select the window description you want to delete out of the list.
4. Click on **Remove**.
The selected window will be removed out of the list.

3.3.8 Configuration preview

How to display the device connections

1. Click on *Show preview*. (image 3-16)
The device connections will be displayed. (image 3-17, image 3-18)
2. Uncheck the check box in front of Show connections to see the devices without wiring.

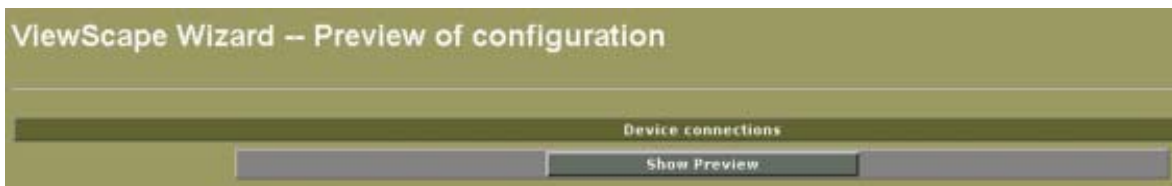

Image 3-16
Show preview

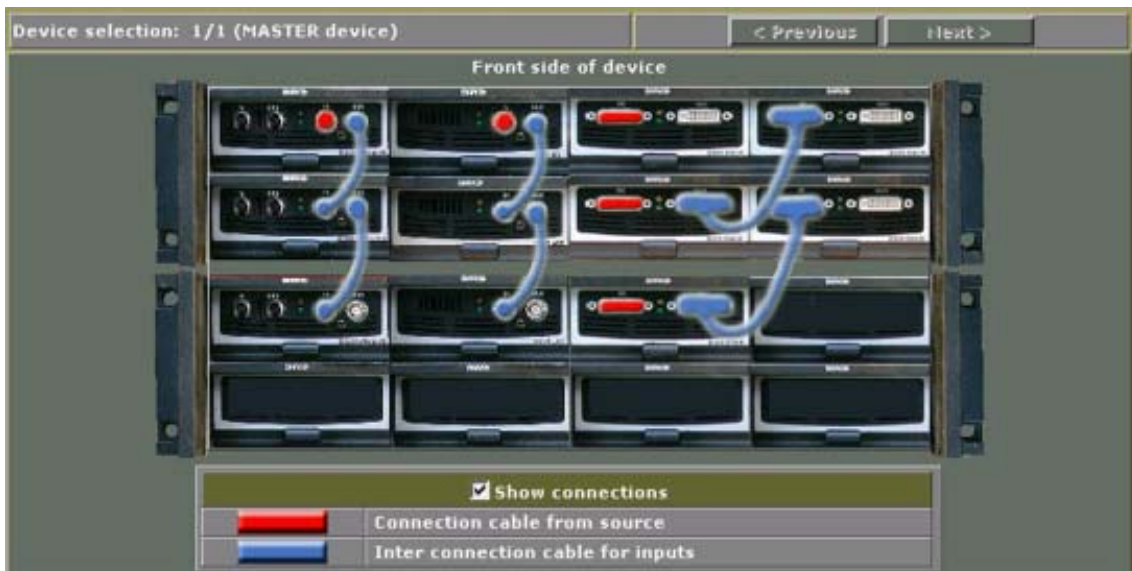

Image 3-17
Source connections to the ViewScope devices

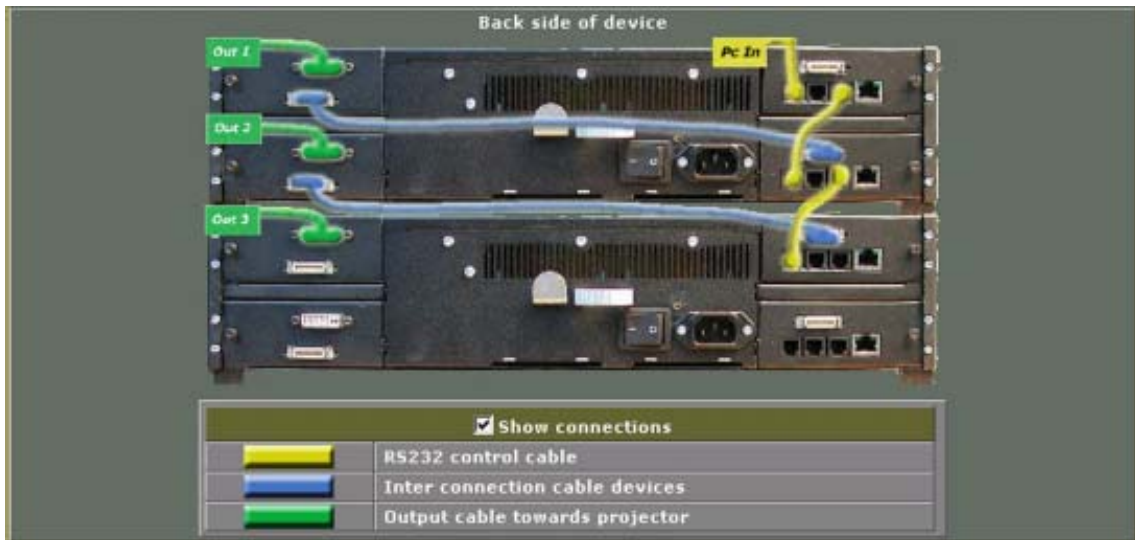

Image 3-18
Communication connections



When more devices are used, use the Next>> and <<Previous button on top of the window to navigate through the configuration.

The master device is indicated on the left corner of the window.

3.3.9 Autodetection of connected devices

Overview

- RS232 Communication Settings
- Start Autodetection
- Serial Numbers

3.3.9.1 RS232 Communication Settings

Start up

1. Click  to reveal the RS232 parameter box. (image 3-19)

3. Configuration Wizard



Image 3-19
RS232 communication settings

Parameter values

Adjust the parameter values to suit the serial RS232 communication values between the local PC and Digitizer.

Default values will already be filled in.

Communication port	Change the Communication port to the serial port as used for connecting the PC to the Digitizer.
Baudrate	Read only value. Set up on 19200.
Databits	Read only value. Set to 8.
Parity	Read only value. Parity is set to none. No parity check is used.
Stopbits	Read only value. Stopbits is set to 1.
Status	This setting is very important as it indicates as to whether the software commands have effect on the system being talked to by the ViewScape Toolset software. When online all commands are sent and acted on, when off-line all commands are not sent to the system devices.

When the Status is set to 'off-line', during some adjustments in system configuration a message will appear to asked if you want to go online.

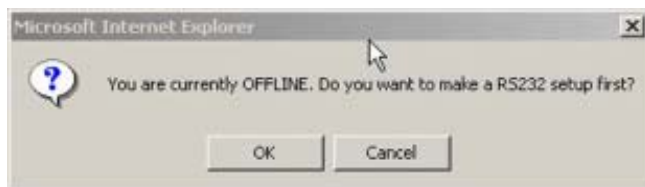

Image 3-20
Offline message

To go online, click on **OK**. To stay offline, click **Cancel**.

To finish the Communication settings:

- When the values are entered, click on **Ok** to update any changes made
- Click on **Cancel** to exit without updating any changes and leaving the existing values unchanged.

3.3.9.2 Start Autodetection

Start up

1. Click on  to initiate the detection process.

Start address

The start address can be filled out by entering an address with the keyboard or by clicking on the '+' or '-' button.

Default = 1.

What will be executed?

All parameters of the detected devices will be downloaded locally.

Status info is given in the *Log Info View* field during the downloading procedure.



Image 3-21
Autodetection and log info view

Wait until the status bar indicates 'Ready' before proceeding with further operations. Continuing with further operations could result in the program locking due to conflicts in communication sending and receiving.

Check in the 'Log Info View' that detection has finished successfully, if so: continue, if not: check the system devices and the cabling connections between them. Also check if all device have been switched on and are in full operational mode.



Repeat the  procedure once again if a rectified problem prevented successful detection originally.

3.3.9.3 Serial Numbers

Start up

1. Click on  to initiate the serial detection process.
2. A pop up screen appears to ask to display the information in a separate window. (image 3-22)
3. Do you want the overview in a separate window?
If yes, click ok (image 3-23)
Note: *Print out this page or save this page in a text file for later use.*
If no, click **Cancel**. (image 3-24)



Image 3-22



Image 3-23
Serial numbers on separate page



Image 3-24
Serial numbers on Autodetect page

3.3.10 Compare Autodetected configuration – Created configuration

Result info

The autodetected configuration is compared with the created configuration.

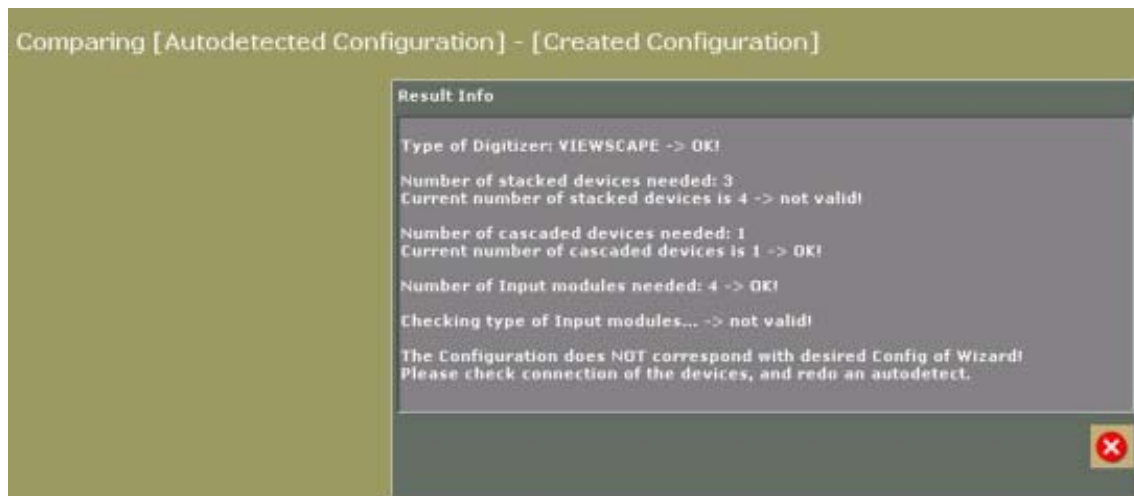

Image 3-25
Compare result

The following items are checked:

- The type of digitizer.
- Number of stacked devices with the number of the current stacked devices.
- The number of cascaded devices with the number of the current cascaded devices.
- Number of input modules needed.
- The type of input modules

When everything is OK, you can continue, otherwise check the connections and the devices.

When clicking on Next>> when everything is not OK, the following message appears:

3. Configuration Wizard

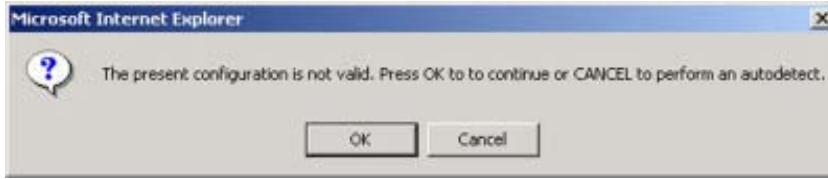

Image 3-26
Configuration message

Click **OK** to proceed.

Click **Cancel** to perform an autodetect.

3.3.11 Updating the configuration

What will be done?

The wizard parameters will be uploaded to the hardware.

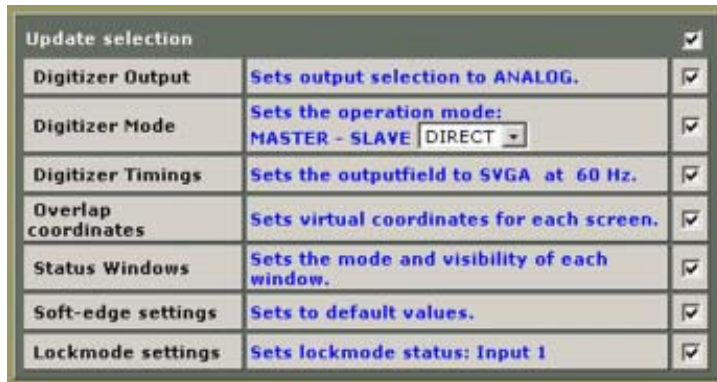

Image 3-27
Update wizard parameters to hardware



Slave direct

slave is directly connected to the previous digitizer by using the sync clock of the previous one.



Slave resync

slave is directly connected to the previous digitizer but the sync clock is restored.

How to select

1. If you want to upload everything in the list, just check the checkbox on top of the window next to *Update Selection*.
2. If you want to upload only part of the list, check only the checkbox next to the items you want to upload.
Note: *When one item is unchecked, the checkbox on top be uncheck too.*

The following items can be updated:

Digitizer output	Set the output to selected output in the wizard
Digitizer mode	Sets the operation mode of the digitizers (master / slave). For Slave, make also the choice between Resync or Direct.
Digitizer Timings	The output field will be set to the selected resolution in the wizard
Overlap coordinates	Virtual coordinates for each screen are set by taking in account the overlap coordinates
Status Windows	Sets the mode and visibility of each window
Soft edge settings	Set to default values
Lock mode settings	Set lock mode status

3. Click **Next>>** to update.

A log window will be displayed in which you can follow the process. (image 3-28)



Image 3-28
Update log window

3.3.12 Output check



When soft edge or Scenergix is available on the projectors, disable this function as edge blending will be done by the digitizers. Consult the projector's user guide to find out how to disable this function.

What will be done?

A multiburst pattern (pixel on - pixel off) will be sent to the projector to check the image quality.

How to proceed for digital output

1. Check the checkbox *Activate multiburst pattern* to check the output projectors. (image 3-29)
2. Click on **Next>>** to activate the pattern.

A log window will be displayed in which you can follow the process. (image 3-30)

3. Visually check the test pattern on the screen. It should look like the test pattern on the test page. (image 3-31)

3. Configuration Wizard

4. Is the result OK?
If yes, go to step 5
If no, follow the set up procedure in the installation manual of the projector and continue then with step 5.
5. Check the radio button in front of *Result is OK* and click **Next>>**.



Image 3-29
Activate multiburst pattern



Image 3-30
Update test pattern log window



Image 3-31
Visual output check

How to proceed for analog output

1. Check the checkbox *Activate multiburst pattern* to check the output projectors (image 3-29).
2. Click on **Next>>** to activate the pattern.
A log window will be displayed in which you can follow the process.
3. Visually check the test pattern on the screen. It should look like the test pattern on the test page. (image 3-32)
4. Is the result OK?
If yes, go to step 8
If no, follow the set up procedure and continue with step 5.
5. Click on **Step1**. (image 3-33)
Consult the user manual of your projector to adjust the timing values (clock settings). Adjust until the number of bands are zero or almost zero.
6. Click on **step2**. (image 3-34)
Adjust the phase of the projector until a sharper images appear without motion. Consult the user manual of the projector to find out how to adjust the phase.

7. If the result is Ok, check the check box next to *Result is OK*.
8. Click **Next>>** to continue.



Image 3-32
Visual output check

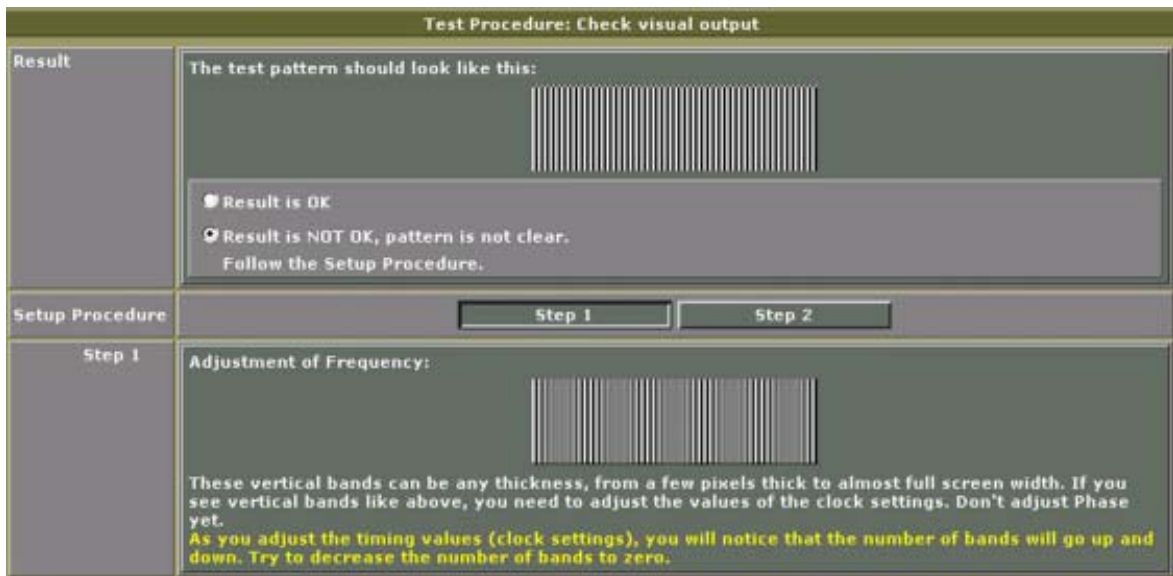

Image 3-33
Adjustment of Frequency

3. Configuration Wizard

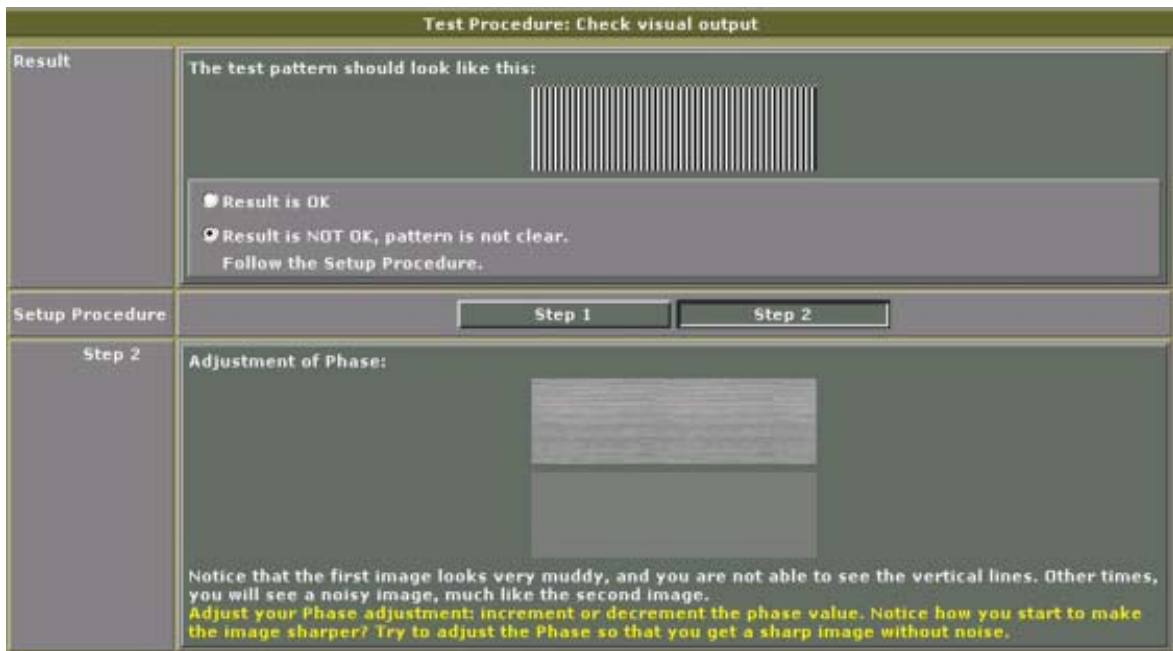

Image 3-34
Adjustment of Phase

3.3.13 Mechanical overlap setup



Overlap zone

The common area of 2 projector images next to each other. In this zone there will be soft edge blending, so that the combined screens will look like one big screen.

What should be done

The overlap area should be mechanically adjusted by shifting the lenses.

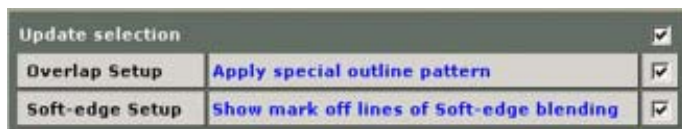

Image 3-35
Update patterns

How to proceed

1. If you want to upload everything in the list, just check the checkbox on top of the window next to *Update Selection*.
2. If you want to upload only part of the list, check only the checkbox next to the items you want to upload.
Note: When one item is unchecked, the checkbox on top will be uncheck too.

The following items can be updated:

- Overlap setup A special outline pattern will be applied
- Soft-edge setup Mark off lines of soft-edge blending will be shown

3. Click on **Next>>** to apply the test patterns.

A log window will be displayed in which you can follow the process. (image 3-36)

4. The *OVERLAPPATTERN* test pattern is by default selected. To select another pattern, click on the drop down box next to *Test pattern* and select the desired pattern.. (image 3-37)
5. Check Active to activate pattern.
6. Adjust the overlap area using the lens shift of the projector until the outline of the pattern of one projector matches the green line of the pattern on the second projector et vice versa. (image 3-38)
Note: *Disable the projector's test pattern.*
7. Click on the < or > button for the next overlap zone and repeat step 6.
8. Adjust eventually the entered overlap value by entering a new value or by clicking on the - or + button.
9. Select the *OUTLINE* pattern and click **Next>>** to continue.



Image 3-36
Log window special overlap patterns

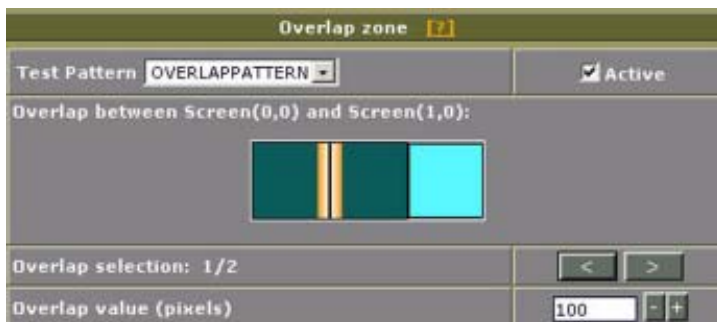

Image 3-37
Overlap zone adjustment

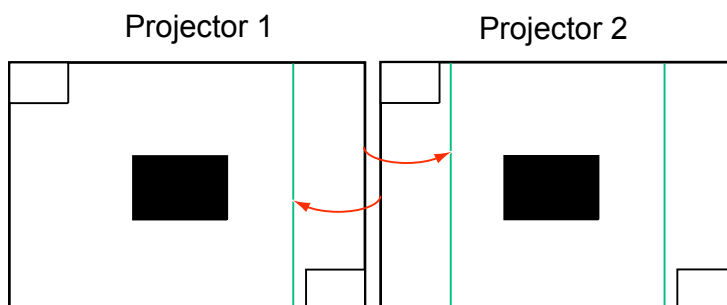

Image 3-38
Overlap area adjustment

3.3.14 Input Balance Adjustment



Consult the user guide of your projector for a more detailed description of how adjusting the input balance.



The indication given on the screen is a general method to adjust the input balance.

Steps to be taken

To adjust the input balance, the following steps have to be executed in the following order:

1. Start with the black balance.
2. Continue with the white balance.

Black balance adjustment

These step are only the basic steps to be taken:

1. Adjust the brightness to a maximum value until there is just no green noise visible in the black areas.
2. Adjust the color levels until there is no red or blue noise visible in the black areas.

White balance adjustment

1. Put red and blue gain to -32 (lowest level).
2. Adjust the contrast to a maximum value until the green noise becomes visible in the white areas and return one step.
3. Adjust the gains until the red and the blue noise becomes visible in the white areas and return one step.

3.3.15 Gamma setup – Soft edge blending

Upload test patterns

1. If you want to upload everything in the list, just check the checkbox on top of the window next to *Update Selection*. (image 3-39)
2. If you want to upload only part of the list, check only the checkbox next to the items you want to upload.
Note: When one item is unchecked, the checkbox on top will be uncheck too.

The following items can be updated:

Gamma setup	A vertical ramp pattern will be displayed
Soft-edge Blending	Soft edge blending will be applied.

3. Click on **Next>>** to apply the test patterns.

A log window will be displayed in which you can follow the process. (image 3-40)

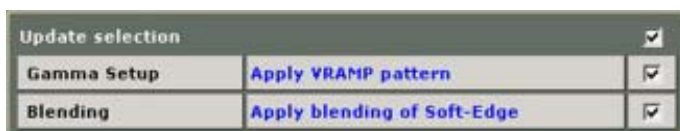

Image 3-39
Updating gamma and soft edge blending



Image 3-40
Update test pattern log window

Gamma setup

1. Select the test pattern by clicking on the drop down box and selecting the desired one. (image 3-41)
2. Check activate to display the pattern.
3. Enter the correct gamma value by clicking on the '-' or '+' button
Or,
click in the input field and enter the correct value with the keyboard.
Note: The entered value should be the same as the gamma setting in the projector.



Image 3-41
Gamma setup

3.3.16 Contrast and Color equalization

What has to be done

The contrast and color of all the projectors should be equal when projecting one big image.

Uploading test pattern

1. Check the checkbox *Apply Bytelevel (full white) pattern* to check the output projectors. (image 3-42)
2. Click on **Next>>** to apply the test pattern.

A log window will be displayed in which you can follow the process.



Image 3-42
Apply bytelevel test pattern

How to equalize

1. Set the color temperature of all projectors to the same value. (image 3-43)
2. Match the colors with the color balance. Start by the highest output so that it matches the lowest output.
3. If the colors are not yet perfect, match the colors by decreasing the contrast of the highest output.

3. Configuration Wizard

Contrast & Color Equalisation [?]	
Step 1	Set the color temperature for all projectors to the same value.
Step 2	If needed: Match the color with the color balance of the highest output, to the lowest output.
Step 3	If needed: Match the color by decreasing the contrast of the highest output.

Image 3-43
Contrast and color equalization

3.3.17 Black level Adjustment of the images

Why

For dark images, the overlap zone will be brighter than the rest of the images. Therefore we can rise the black level of the remaining image (excluding the overlap zone).

How to adjust

1. Check the checkbox *Apply Bytelevel pattern* to check the output projectors. (image 3-44)
2. Click on **Next>>** to apply the test pattern.

A log window will be displayed in which you can follow the process.

3. If you want to change the test pattern, click on the drop down box and select the desired pattern. (image 3-45)

Note: Be sure that *Active* is checked.

Tip: *Bytelevel (black)* is the best test pattern to adjust the black level.

4. Adjust the black level for all screens at the same time or screen by screen. To make the choice, click on the drop down box and make your selection.
5. If you want to set the value for Red, Green and Blue to the same value, check *Item R, G, B*.
6. If you want to link Red, Green and Blue to increment with the same value, check *Link R, G, B*.
7. Adjust the black level by adjusting Red, Green and Blue until the black level of area A is equal with B, C etc. (image 3-46)



Image 3-44
Send blacklevel test pattern



Image 3-45
Black level adjustment

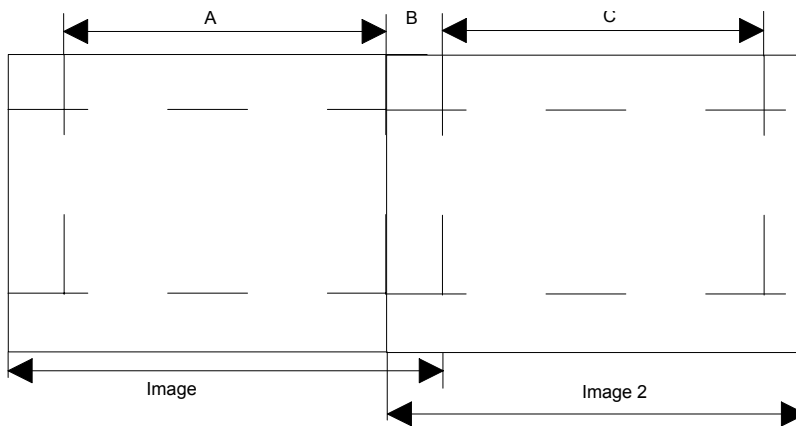

Image 3-46
Black level adjustment

- A image 1 except overlap
- B Overlap area image 1 and image 2
- C image 2 except overlap

3.3.18 Loading final settings

Loading Coordinates

1. If you want to upload everything in the list, just check the checkbox on top of the window next to *Update Selection*. (image 3-47)
2. If you want to upload only part of the list, check only the checkbox next to the items you want to upload.
Note: When one item is unchecked, the checkbox on top will be unchecked too.

The following items can be updated:

Overlap coordinates	Virtual coordinates for each screen will be uploaded
Patterns	All patterns will be switched off
Lockmode	Restores status of lockmode

3. Click **Next>>** to apply.

A log window will be displayed in which you can follow the process.

When finished a result window will be displayed. (image 3-48)



Image 3-47
Set Virtual coordinates

3. Configuration Wizard



Image 3-48
Wizard result window

3.3.19 Finishing the wizard

Finish wizard

1. Click on **Finished**.

A save question will be displayed. (image 3-49)

2. If you want to save the settings, click **OK**, otherwise click **Cancel**.

The save configuration to file window will be displayed. (image 3-50)

3. Click Proceed to finish the wizard.

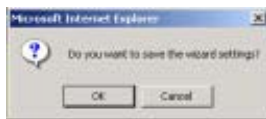

Image 3-49
Setting save



Image 3-50
Save to file window

Saving to disk

1. Click on the disk icon to download the file (image 3-50).

The File download window opens. (image 3-51)

2. Check *Save this file to disk* and click **OK**.

Windows explorer opens.

3. Select a location and change eventually the file name.

4. Click on **OK**.

The file will be downloaded.

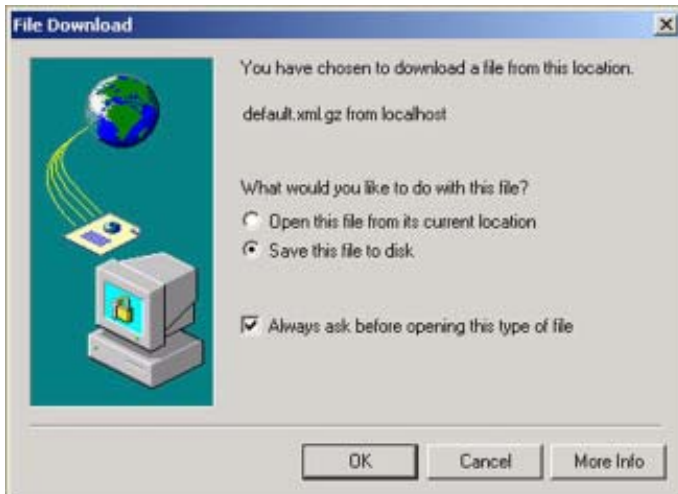

Image 3-51
File download window

3.4 Loading a saved configuration

How to load

1. Select *Open an existing file*. (image 3-52)
2. Click on **Next>>**.

The load configuration window will be displayed. (image 3-53)

3. Enter a complete path and file name and click **Next>>**
Or,
click on **Browse**.

A browser window will open.

4. Select a file and click **Open**.

The valid files must have the extension *.xml.gz*.

The configuration will be loaded.

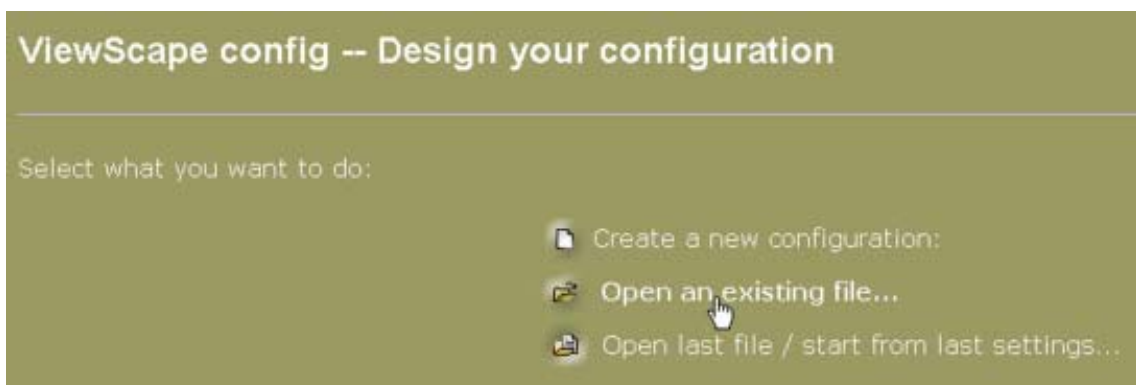

Image 3-52
Select for the 'existing file' way

3. Configuration Wizard

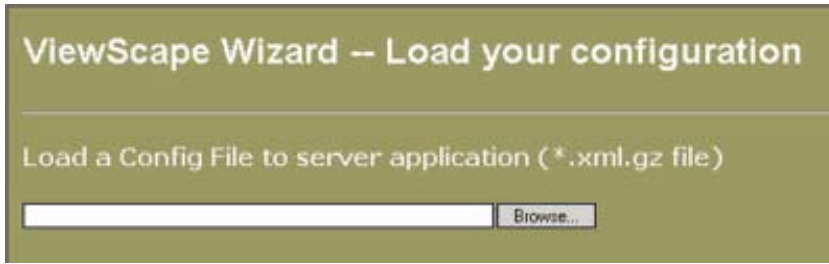

Image 3-53
Load configuration window

4. THE VIEWSCAPE APPLICATION

Overview

- Menu structure overview
- Display selection

4.1 Menu structure overview

Window parts

The start up window of the ViewScape application can be split up in different parts. These parts will be explained more in detail in the following chapters.

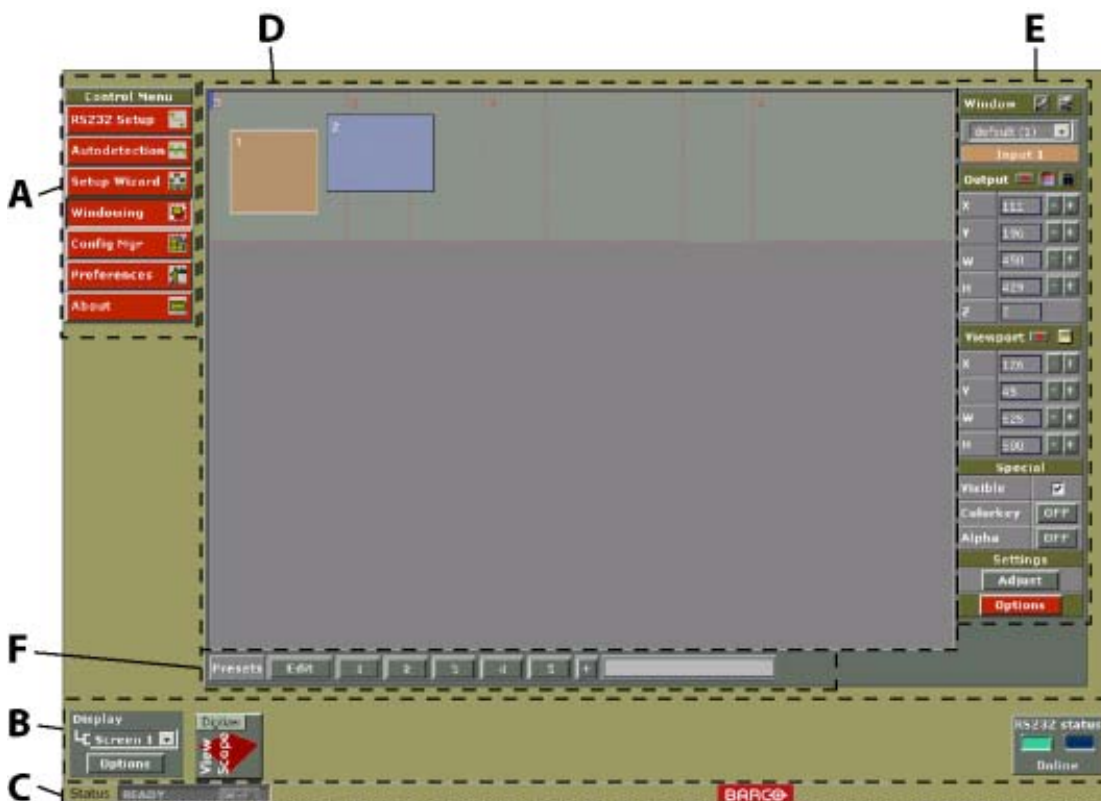

Image 4-1
The different window parts

A	The control menu. This menu gives access to the different GUI view to set up the configuration.
B	Overview area. Gives an overview of the display configuration, the ViewScape digitizers and the communication status.
C	Status bar. Gives an overview of the status of the application.
D	Window preview (workspace). Gives a preview of the actual position of the different windows.
E	Window controls (window input box)
F	presets for stored layout configurations (window parameters).

Table 4-1

4.2 Display selection

Display selection

The drop down box below Display contains all available screens. To select a display click on the drop down box and select the desired screen.



Image 4-2
Display selection

Apply level setting

When multiple screens are used, changing a setting can be interpreted in different ways. E.g. changing a setting on an input of the master digitizer can be interpreted as changing only the setting for that specific input or for the stacked inputs.

How to use this setting

Click on **Options** in the *Display selection box* and the *Application level window* reveals.

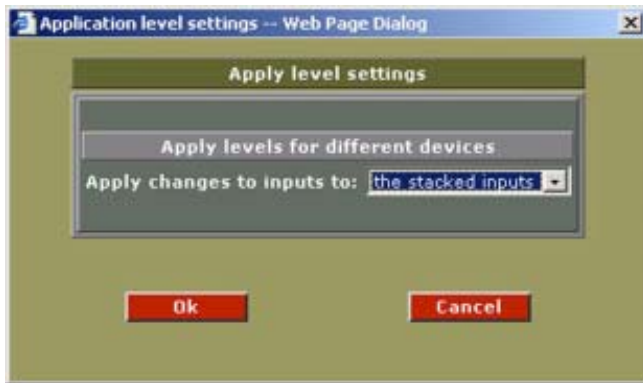

Image 4-3
Apply level settings

Make your selection and click **OK**.

5. RS232 SET UP

Overview

- Start up
- Quick status change of RS232

5.1 Start up

To to start up

1. Click on RS232 in the Control menu.

The RS232 communication window opens. (image 5-1)



Image 5-1
RS232 Communication window

Parameter values

Adjust the parameter values to suit the serial RS232 communication values between the local PC and Digitizer.

Default values will already be filled in.



Communication port	Change the Communication port to the serial port as used for connecting the PC to the Digitizer.
Baudrate	Read only value. Set up on 19200.
Databits	Read only value. Set to 8.
Parity	Read only value. Parity is set to none. No parity check is used.
Stopbits	Read only value. Stopbits is set to 1.
Status	This setting is very important as it indicates as to whether the software commands have effect on the system being talked to by the ViewScape Toolset software. When online all commands are sent and acted on, when off-line all commands are not sent to the system devices.

5. RS232 Set up

When the Status is set to 'off-line', during some adjustments in system configuration a message will appear to asked if you want to go online.

To go online, click on **OK**. To stay offline, click **Cancel**.

To finish the Communication settings:

- When the values are entered, click on  to update any changes made
- Click on  to exit without updating any changes and leaving the existing values unchanged.

5.2 Quick status change of RS232

Quick Change

Click on the non selected square of the RS232 window to change the status.

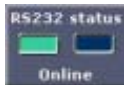

Image 5-2
Status change RS232

When a green square is visible : online

When a red square is visible : offline

6. AUTODETECT PAGE

Overview

- Start up of the Autodetect page
- Actions on the Autodetection page

6.1 Start up of the Autodetect page

How to start up

1. Click on **Autodetection** in the *Control menu*. (image 6-1)
The autodetection page will be displayed. (image 6-2)



Image 6-1
Select Autodetection



Image 6-2
Autodetection page

6.2 Actions on the Autodetection page

Possible actions

RS232 Setup	see "RS232 Set up", page 43
Start Autodetection	see "Start Autodetection", page 25
Serial Numbers	see "Serial Numbers", page 26

7. WINDOWING

Overview

- Input and Display configuration
- Selecting a Window
- Moving a window
- Scaling Windows
- Making group changes to a window
- Z-Order
- Aspect Ratio
- Changing a window name
- Changing the window mode
- Locking a window
- Creating a full window
- ViewPort
- Visibility setup of a source
- Color key
- Alpha Blending
- Settings
- Work Space Resolution
- Preset Configurations

7.1 Input and Display configuration

What can be done with this configuration

This window enables:

- Windowing changes on various inputs.

About boxes in the window

The red bordered rectangular boxes with no filling represent the different screens in the workspace. Other boxes in the workspace represent input sources and are color filled. The currently selected input has a white border while the not selected sources have a black border. The sources containing the background are by default locked.

All input sources are identified by numbering and color.

The window controls on the right, allow input specific changes and effects.

These includes :

- input positioning
- input viewporting
- input visibility
- input color keying
- input alpha blending

The workspace allows for locating, moving, scaling up/down sources, enable or disable sources and make adjustments to display and source environment.

Only window boxes overlapping the display box (red outlines) will be visible on the screen.

7.2 Selecting a Window

Overview

There are two ways to select activate a window. One via the workspace and one via the Window input box.

Window selection via the workspace

1. Click with your mouse on the window you want to select.

If the selected window is not a background, the outline will be come white.

Window selection via the Window input box

1. Click on the drop down box containing the different windows. (image 7-1)
2. Select the desired window.

All windows are indicated with their name, followed a input number between brackets. When no name was entered during the configuration set up, the name was set to *default*.

The selected window becomes active. The input label below the selection box changes to corresponding input and the background color of that label changes also to the same background color of the selected window. All output settings for that specific source change correspondingly.

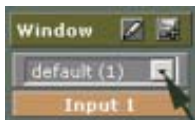

Image 7-1
Window selection

7.3 Moving a window

Moving via the workspace

1. Click on a window and hold the mouse button down to grab the selected window. (image 7-2)
2. Move the window as is required. (image 7-3)

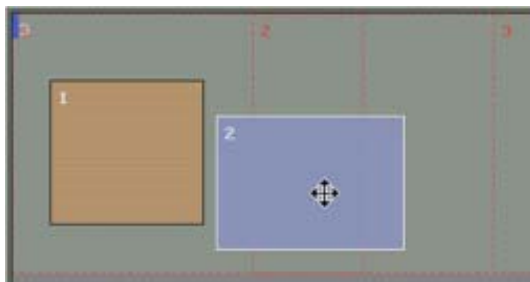

Image 7-2
Select window

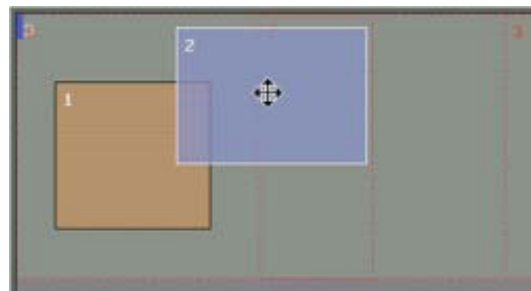

Image 7-3
Move window

Moving via the Window Input Box

1. Select the window you want to move.
2. Change the X and Y value indicating the start position of the window by clicking on the + or - keys
Or,
by entering a new value with the keyboard. (image 7-4)



Image 7-4
Moving via the output box

7.4 Scaling Windows

Scaling via the workspace

1. Move your mouse to the corner of a window.

The cursor will change to an arrow cursor under 45°. (image 7-5)

2. Click on the corner of a window while holding the mouse down.

3. Move the mouse to either down-scale or upscale the selected source, as is required.

The coordinates of the selected window will be automatically adjusted in the windowing menu box, in relation to any re-sizing or moves. (image 7-6)

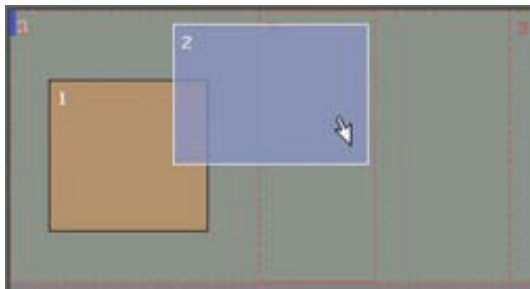

Image 7-5
Start Scaling window

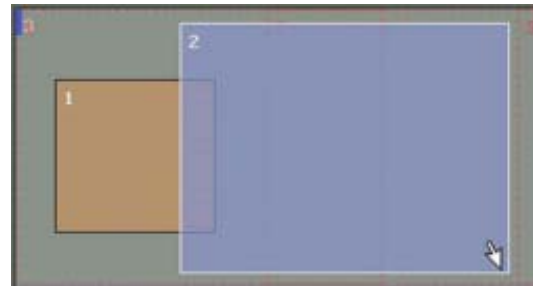

Image 7-6
Scaling the window

Scaling via the Window Input Box

1. Select first a window.
2. Change the width and height value by pushing on the + or - button.

Or,

by entering the new values with the keyboard. (image 7-7)

Note: The left upper corner is fixed during the scaling.



Image 7-7
Scaling via the Output box



When a typical aspect ratio is associated with the selected window, the height and width are linked to each other. When changing one of them, the other dimension will change accordingly.

7.5 Making group changes to a window

What is possible?

The dimensions and the relative position of a window can be changed by entering new values in the output box but the changes will only be applied to the real window at the end after effectively applying the changes. The preview in the workspace will change each time a value is adapted.

How to make group changes

1. Select an input (window).
2. Click on the group change icon. (image 7-8)

The background of the adjustable fields will change to white. The group change icon will blink. (image 7-9)

3. Change the values for X, Y, W and H to the desired values.
4. Click on the blinking group change icon.

The changes will be applied to the display.



Image 7-8
Group changes
selected



Image 7-9
Group changes

7.6 Z-Order



Z-order

The layer sequence in which windows will be displayed in relation to one another.

Z-order change via the workspace

It is possible to adjust the Z-Order or layering scheme of the windows in relation to one another.

1. Click with the right mouse button upon any particular source (window).

A pop-up window appears. (image 7-10)

2. Move your mouse over the Z-order item in the pop up window to the right until detailed info appears. (image 7-11)

3. Select from the four choices to change the order of the layering.

One Up	moves the selected source up one layer
One down	moves the selected source down one layer
To front	moves the selected source to the top layer
To back	moves the selected source to the bottom layer

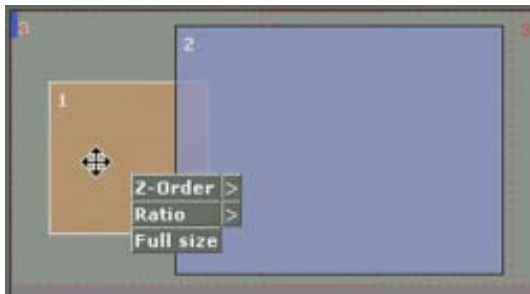

Image 7-10
Z-order change

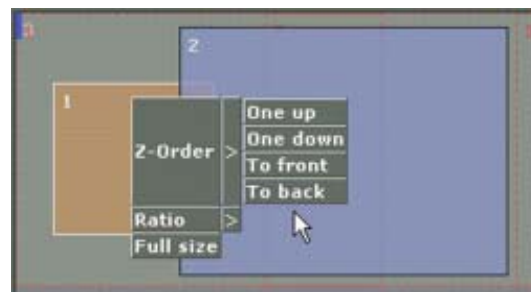

Image 7-11
Z-order change

Z-order change via the Window input Box

1. Select the input you want to change in order.
2. Click on the arrow next to Z-order in the *Window Input Box*. (image 7-12)

A windows popup appears. (image 7-13)

3. Select one of the four choices to change the order of the layering.

The window layering will change. The new position will be indicated in the box next to Z.



Image 7-12
Select Z-order



Image 7-13
Z-order selection

7.7 Aspect Ratio



Aspect ratio

horizontal & vertical dimension in which the window will be displayed, e.g. 4 by 3 or 16 by 9.

How to change

It is possible to adjust the Aspect Ratio of a window.

1. Click with the right mouse button upon a source.

A pop-up window appears.

2. Select Ratio and move the mouse to the right.

The menu will expand with the different ratios. (image 7-14)

3. Select the desired ratio.

Note: while selecting a typical aspect ratio, the width and height in the window box are coupled.

The following ratios are available:

- 3/2
- 4/3
- 14/9
- 16/9
- 21/9
- Snap to : set ratio to current dimensions
- None : no typical aspect ratio installed.

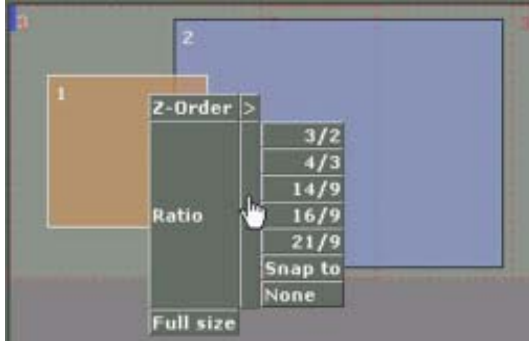

Image 7-14
Changing the aspect ratio

7.8 Changing a window name

Overview

Each window can have a specific name. That name can be entered while configuring the configuration but can be changed at any time while working in the window workspace.

How to change

1. Select first the window (source) you want to change the name.
2. Click on the name change icon. (image 7-15)
A user prompt window will be displayed. (image 7-16)
3. Enter a new name with the keyboard.
4. Click **OK** to change the name of the selected window.



Image 7-15
Click on change name icon



Image 7-16
Name change prompt window

7.9 Changing the window mode

Different window modes

The following modes are available:

- Single mode : for a normal window used anywhere on the display.
- Multiple background : to fill the complete background of display. That window cannot be moved or scaled. Z-ordering is still possible.

Mode selection

1. Select the window you want to change the mode.
2. Click on the *modify window* icon.
The *Window Mode* window appears.
3. Click on the drop down box next to mode and select the desired mode.
The following modes are possible:
 - Single mode
 - Multiple background mode
4. Do you want to change to *Single mode*?
If yes, Click on *Single mode* and click **OK**.
If no, go to step 5
5. Select *Multiple Background*.

An extra item appears about the background.

You can construct the background with:

- independent (hard edged) sources: two inputs connected in tandem will be combined together to form the background. The overlap will be organized by the ViewScope.
 - overlapped sources: one input is used as the overlap is realized inside the source.
6. Click **OK** to continue.

If a background was previously installed, a message to uninstall the previous background will be displayed. (image 7-17)

7. Windowing

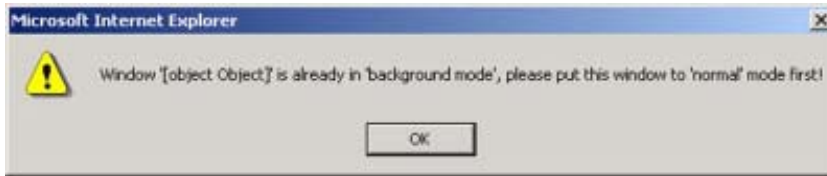

Image 7-17
Background message

7.10 Locking a window

Why

A window can be locked so that no changes can be made to dimensions and the relative position in the display. Z-ordering is still possible.

How to lock

1. Select an input (window).
2. Click on the padlock icon. (image 7-18)

The selected window is locked on its actual position.



Image 7-18
Window lock

7.11 Creating a full window

What is possible?

One input window can be transformed to a full window on all screens (= complete display) or on specific screen. These setting can be locked and the image can be send to back.

How to start up

1. Select an input (window) on which you want to apply the full window settings.
2. Click on the full window icon in the Output box. (image 7-19)

The *Full window* dialog box will be displayed. (image 7-20)

Or,

Right click on the window you want to enlarge to a full window.

A pop up menu appears. Select Full size. (image 7-21)

The *Full window* dialog box will be displayed (image 7-20).



Image 7-19
Full window selection



Image 7-20
Full window settings

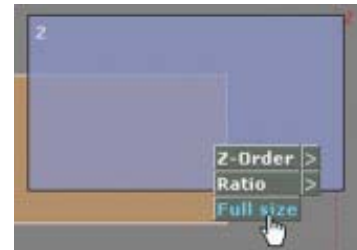

Image 7-21
Select full size

Entering the settings

1. Click on the *Full size on* drop down box and select the desired screen.

Possible choices are: all to select the complete display or a typical screen number out of the list forming the display.

Default value : all

2. Do you want to lock this window?
If yes, Check the checkbox next to padlock icon
3. Do you want to send this window to the back?
If yes, Check the checkbox next to *Send to back*.
4. Click on **OK** to apply these settings.

7.12 ViewPort

Overview

- General
- Creating a ViewPort for a single source
- Creating a viewport for a multiple 'independent' (hard edged) background
- Creating a viewport for a multiple 'overlapped' background
- Making group changes to the viewport
- Apply Viewport setting source 1 to source 2

7.12.1 General

Overview

ViewPort refers to a positional point on the input image (with X & Y coordinates). Associated to that point is a horizontal distance along, plus a vertical distance down. This then defines a viewport or cutout specific to that input.

Depending on the version of the used Internet Explorer, the viewport menu box will have an extra icon.



Image 7-22
Viewport set up for
IE5.5 or lower



Image 7-23
Viewport set up for
IE6.0

- X Horizontal start position of source window in pixels referenced to the input source reference.
- Y Vertical start position of source window in pixels referenced to the input source reference.
- W Horizontal size of source window in pixels (width)
- H Vertical size of source window in pixels (height)

7.12.2 Creating a ViewPort for a single source

By entering the coordinates

1. Select an input (window).
The coordinates for the selected source will be filled out.
2. Click on the '+' or '-' button next to X, Y, W and H to create the desired viewport.
Or,
click in an input field and enter the desired value with the keyboard.

By dragging with the mouse (only for Internet explorer 6.0)

1. Select an input (window).
The coordinates for the selected source will be filled out.
2. Click on the view control icon. (image 7-24)
The View Control window reveals. (image 7-25)
 - The colored window indicates the actual viewport for the indicated source. The color of the window is the same as the color of the source in the system configuration window.
 - The gray background with the indication 'Input source' is the real size of the input source.
3. To resize the Viewport, move your mouse to a corner of the colored square. The cursor changes to a white arrow. Hold down the left mouse button and move to the desired position. (image 7-26)
4. To move the viewport, move your cursor to the center area of the colored square, hold down the left mouse button and move the complete square to the desired position on the input source. (image 7-27)



Image 7-24
View control selected



Image 7-25
View control window

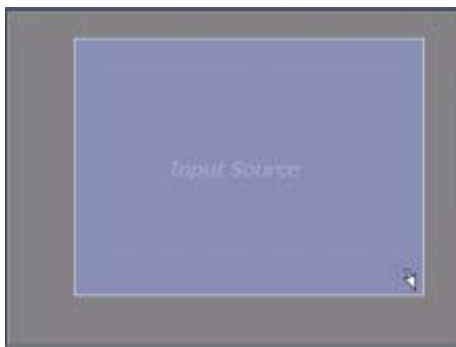

Image 7-26
Resizing a viewport

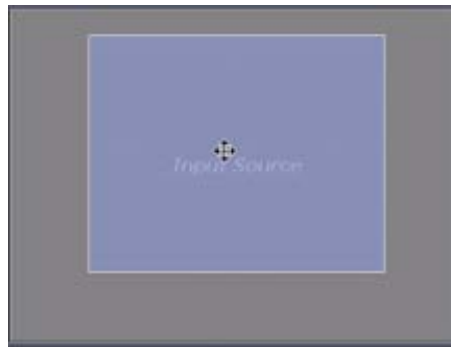



Image 7-27
Moving a viewport



While in the Viewport Control window, it is still possible to enter the values yourself.



Click on  icon to display the best fit of the source representation on the canvas when the window is too big or too small..

Go back to the default values

1. Click on the default icon. (image 7-28)

A message will be displayed to indicate that the default settings will be loaded. (image 7-29)

Or,

for IE6.0 click on the **Default** button.

A message will be displayed, indicating the default coordinates. Click **OK** to continue. (image 7-30)

7. Windowing



Image 7-28
Selecting default
viewport



Image 7-29
Default viewport settings
will be loaded



Image 7-30
Default viewport settings

7.12.3 Creating a viewport for a multiple 'independent' (hard edged) background

By entering the coordinates for each source in a screen

1. Select the multiple background.
2. Click on Viewport setup. (image 7-31)

The viewport window for multiple 'independent' (hard edged) background will be displayed. (image 7-32)

If you have x screens, you will have $2x-1$ viewports to adjust.

E.g. multiple background is built up by source 3 and 4. The following viewports have to be set up:

- screen 1, source 3
- screen 1, source 4
- screen 2, source 3
- screen 2, source 4
- etc. (image 7-33)

3. Select a screen by clicking with the mouse on a screen.

The actual viewport settings will be shown.

4. Change the viewport settings until the image is correctly displayed.

Note: Creating a correct image is an interaction between two next to each other situated viewports.



Image 7-31
Select viewport setup



Image 7-32
Viewport window for Multiple 'independent' (hard edged) background

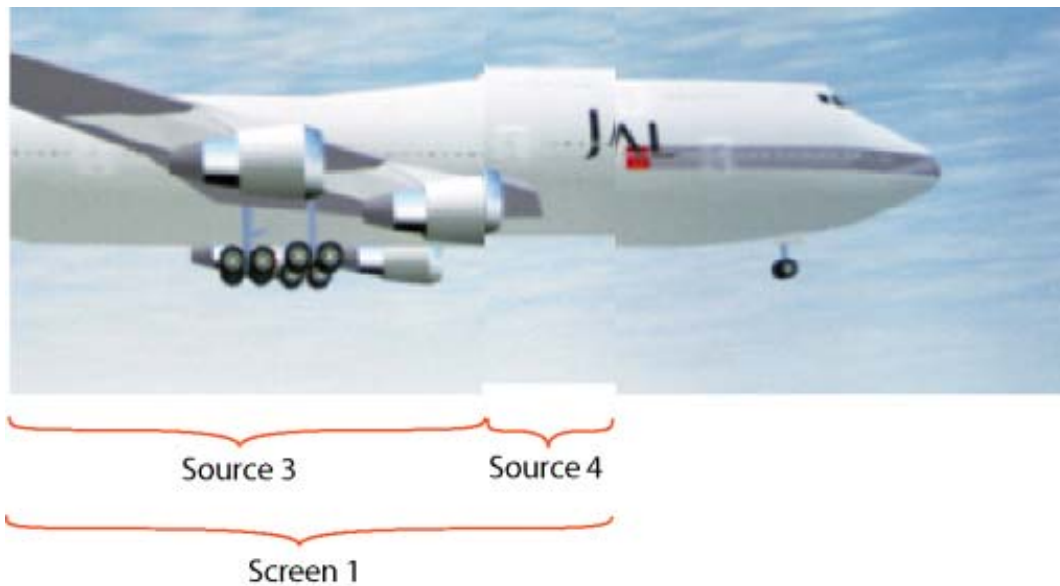

Image 7-33
Viewport set up for multiple background

7.12.4 Creating a viewport for a multiple 'overlapped' background

By entering the coordinates for each source in a screen

1. Select the multiple background.
2. Click on Viewport setup.

The viewport window for multiple 'overlapped' background will be displayed. (image 7-34)

If you have x screens, you will x viewports to adjust. (image 7-35)

3. Select a screen by clicking with the mouse on a screen.

The actual viewport settings will be shown.

4. Change the viewport settings until the image is correctly displayed.

Note: Creating a correct image is an interaction between two next to each other situated viewports.



Image 7-34
Viewport window for Multiple 'overlapped' background

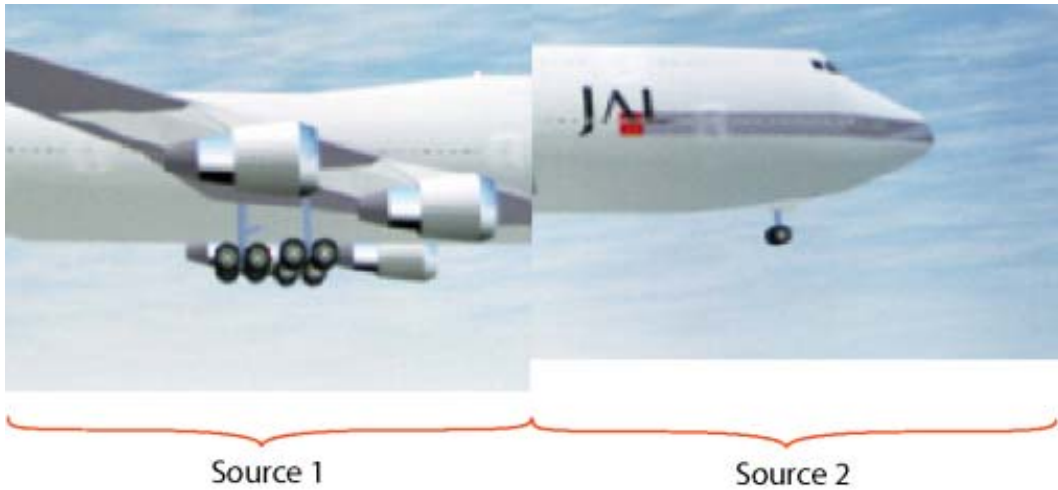

Image 7-35
Viewport for multiple 'overlapped' background

7.12.5 Making group changes to the viewport

Making group changes

1. Click on the group change icon. (image 7-36)
The background of the adjustable fields will change to white.
The group change icon will start blinking.
2. Make the necessary changes to those input fields.
3. Click again on the blinking group change icon.
All changes will be applied simultaneously.



Image 7-36
Select viewport group changes

7.12.6 Apply Viewport setting source 1 to source 2



Only available for Internet Explorer 6.0.

What can be done

The viewport setting of one source can be copied to the viewport settings of another source by simple drag and drop.

How to apply

1. Select the source from which you want to copy the viewport settings.
2. Click on the Viewport Control icon and hold down the mouse button. (image 7-37)
3. Drag the icon to the desired source square in the workspace. (e.g. to source 2)
4. Release your mouse button when on the desired source square.

The settings will be copied from the original source to the new source (in the image example from source 1 to source 2).

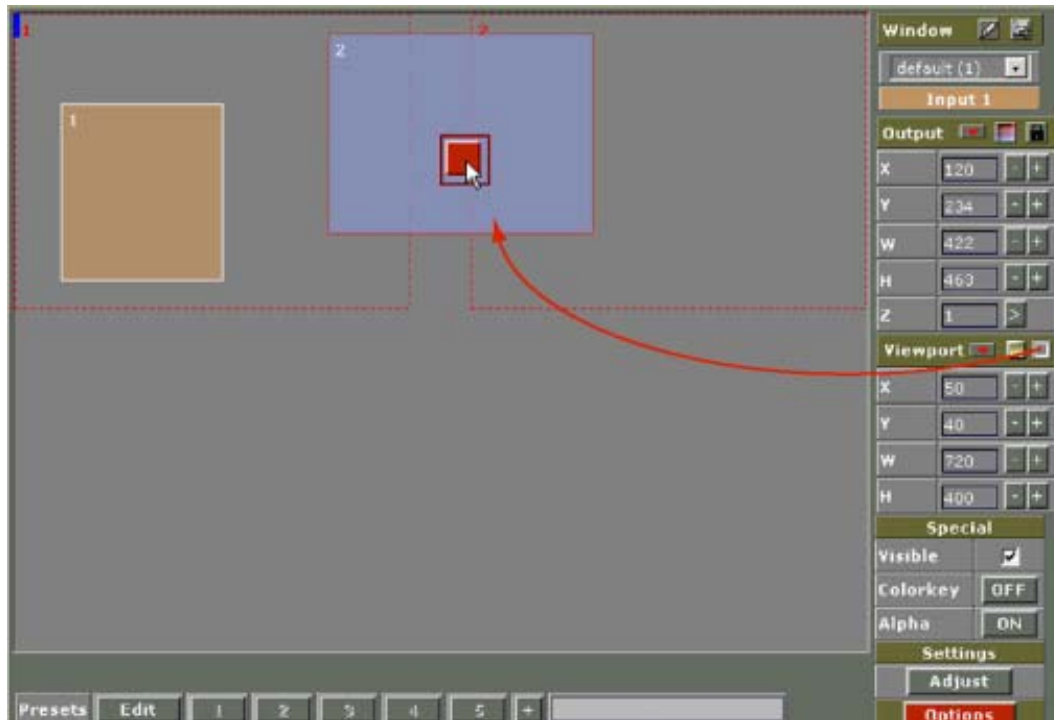

Image 7-37
Copy viewport settings

7.13 Visibility setup of a source

To set up

1. Uncheck the checkbox next to Visible in the Special input box. (image 7-38)

The selected source will not longer visible. The representation of this source on the workspace will be shaded grey to indicate that the content is invisible.

Default : checkbox is checked.



Image 7-38
Select Visible

7.14 Color key



Color key

Sometimes also called chroma key. This is a method of combining two video images. An example of chroma keying in action is the nightly news person standing in front of a giant weather map. In actuality, the person is standing in front of a blue or green background and their image is mixed with a computer-generated weather map. This is how it works: a TV camera is pointed at the person and fed along with the image of the weather map into a box. Inside the box, a decision is made. Wherever it sees the blue or green background, it displays the weather map. Otherwise, it shows the person. So, whenever the person moves around, the box figures out where he is, and displays the appropriate image.

Example images of color keying

Take e.g. two image. One taken on a full color background and the other a normal image. The full color background will be replaced by the second image via the principle of color keying.



Image 7-39
Zebra on a single color



Image 7-40
Full color image



Image 7-41
Result image after color keying

Start up

1. Click on the **ON** or **OFF** button of the Window Input Box next to *Color key*. (image 7-42)

The color key window opens with the same status as indicated in the *Special* menu. (image 7-43, image 7-44)



Image 7-42
Color key window
activation

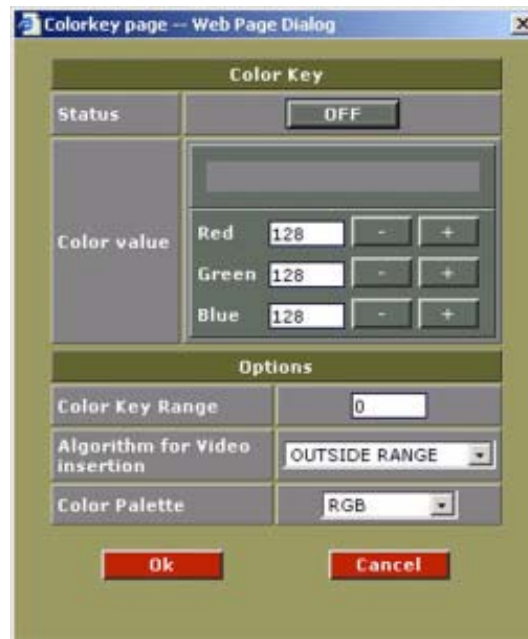

Image 7-43
Color key window status OFF

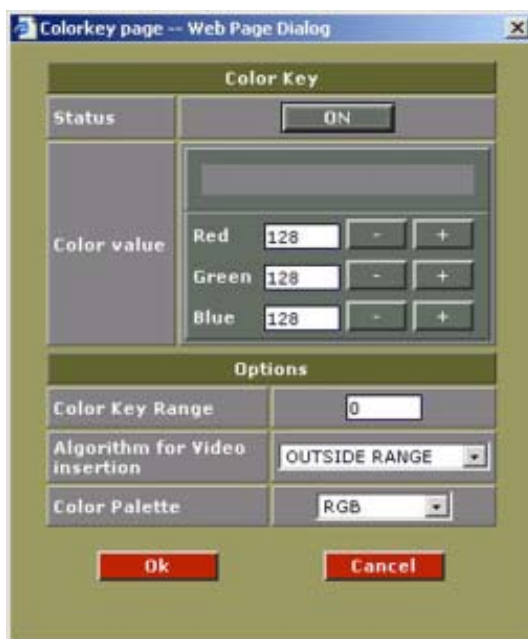

Image 7-44
Color key window status ON

Status

ON indicates color key status active.

OFF indicates color key status disabled.

Color values

Manually enter in the values of Red, Blue & Green in a ranges 0-255.

This will generate the color that will be color keyed.

The color key color will be visible in the box above the values.

Range

Definition of color key value range. This range can be used to avoid color keying on one specific color value.

E.g. when the value is 10, all colors within a range -10 to +10 around the initial value will be used for color keying.

Algorithm

Algorithm for the Video insertion. You can insert the video starting from the color value and every value higher than this color starting from the color value and every value lower than this color, inside the range or outside the range.

Possible selections:

higher	color higher than the range will be inserted
lower	color lower than the range will be inserted
equal	color equals the color value will be inserted
inside range	colors inside the range will be inserted
outside range	colors outside the range will be inserted

Color Palette

Keying on Red, Green & Blue together

Keying on only Red or Green or Blue : this can be useful when there is some (white) noise on the image.

Apply changes

Click on  to store any change and activate any action performed.

Click on  to exit without storing any changes performed.

7.15 Alpha Blending



Alpha Blending

Alpha Blending enables the ability to add transparency to any selected source.

Overview

Alpha blending can be executed on a graduation scale of 0–255. With 255 being transparent or invisible and 0 being solid.



Image 7-45



Image 7-46



Image 7-47

Start up

1. Click on the **ON** or **OFF** button of the Window Input Box. (image 7-48)
The Alpha blending window opens.



Image 7-48
Alpha blending selection

Status

- ON** indicates Alpha blending status active
- OFF** indicates Alpha blending status disabled.

7. Windowing

Alpha Value

The lower the value the image is solid.

0 = solid image

255 = transparent or invisible

Apply changes

Click on  to store any change and activate any action performed.

Click on  to exit without storing any changes performed.

7.16 Settings

Adjust

1. Select an input (window).
2. click on **Adjust**. (image 7-49)

The settings window of the selected source will appear.

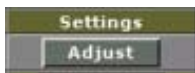

Image 7-49
Adjust settings source

7.17 Work Space Resolution

How to start up?

1. Click upon **Options** in the Window Input Box to reveal the Windowings Options page. (image 7-50)





Image 7-50
Work space resolution

Size adjustment of the resolution

1. Adjust the size of the resolution of the work area using the buttons  to either zoom in or out of the window and display boxes.

The width and height aspect ratio change simultaneously according the adjustments.

See image 7-51, image 7-52.

2. Check the  box to update immediately any changes made.
3. Click upon  to apply any changes made
4. Click upon  to exit without applying changes

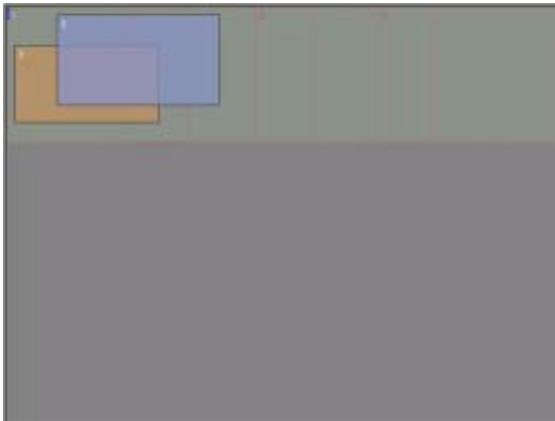

Image 7-51

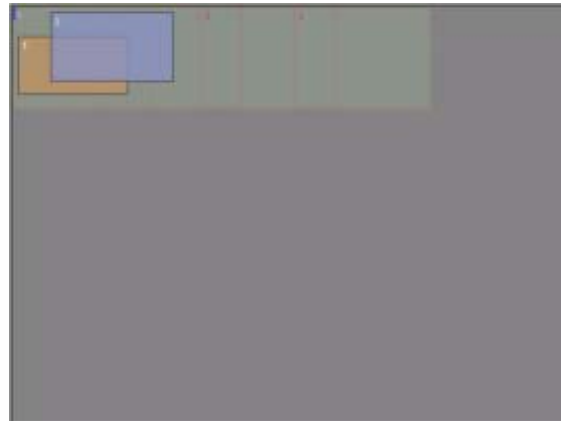

Image 7-52

7.18 Preset Configurations

Overview

- Saving a configuration
- Loading a configuration, way 1
- Loading a configuration, way 2
- Loading a configuration, way 3
- Removing a predefined configuration

7.18.1 Saving a configuration

How to save

1. Make your configuration as described before.

2. Click on 

The Preset web dialog box opens. (image 7-53)

3. Select one of the 10 presets with the mouse. The first 5 are on the screen. Use the scroll bar to see the next 5 presets.

The selected preset line becomes blue. (image 7-54)

7. Windowing

4. Click on **Save** to save the configuration.

If preset is empty, the configuration will be saved.

If the preset is not empty, a message appears. (image 7-55)

Before really saving the preset layout configuration, a preset information input window will pop up. (image 7-56)

5. Click in the input field and enter a name or information about the preset. Click on **OK**.

6. Click **OK** to override the old settings.

Or,

- Click **Cancel** to select an empty preset.



Image 7-53
Preset configuration window



Image 7-54

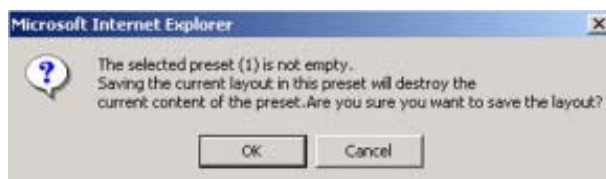

Image 7-55



Image 7-56
Info preset layout configuration

7.18.2 Loading a configuration, way 1

way 1

1. Click on one of the four preset buttons on the system configuration screen. (image 7-57)

If a configuration is stored behind the selected button, this configuration will be loaded. If nothing is stored behind the selected button, nothing will change on the screen.



Image 7-57



When moving your mouse over a preset button, info about this preset will be displayed in the info window next to the buttons.



Image 7-58
Preset info on mouse over

7.18.3 Loading a configuration, way 2



When moving your mouse over a preset button, info about this preset will be displayed in the info window next to the buttons.



Image 7-59

Way 2

1. Click on **Edit**

The Preset web dialog box opens. (image 7-60)

2. If it stored on preset 1 to 5, click on desired preset button on the system configuration screen. If stored on preset 6 to 10, click first on + to display the next 5 presets and click then on the desired preset button.

The selected preset line becomes blue. (image 7-61)

3. Click on **Load** to load the predefined configuration.

A load message screen appears. (image 7-62)

4. Click **OK** to load the selected configuration.

Or,

Click **Cancel** to abort the loading operation.



Image 7-60



Image 7-61

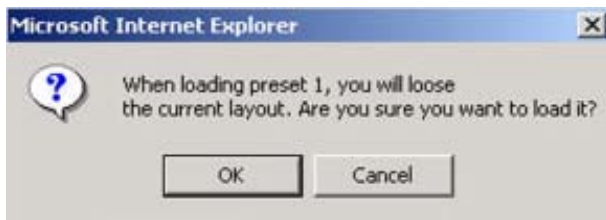

Image 7-62

7.18.4 Loading a configuration, way 3

Way 3

1. Click on the keyboard icon ().

A keyboard representation is displayed. This representation is displayed with alpha blending so that the windows behind it are still visible. (image 7-63)

2. Enter the number corresponding with the preset configuration with the digit keys on your keyboard (0 stands for 10).

Or,
click with the mouse on the corresponding number.

The predefined location will be loaded.



Image 7-63
Keyboard representation

7.18.5 Removing a predefined configuration

How to remove

1. Click on **Edit**

The Preset web dialog box opens. (image 7-64)

2. Select a used preset with the mouse. Use the scroll bar if necessary to reach preset 6 to 10.

The selected preset line becomes blue. (image 7-65)

3. Click on **Remove** to remove the selected preset.

4. A warning message will appear. (image 7-66)



Image 7-64



Image 7-65



Image 7-66

8. CONFIGURATION MANAGER

Overview

- Overview of the configuration manager
- Saving a Configuration
- “Save as” a Configuration
- Deleting a Configuration
- Loading a Configuration

8.1 Overview of the configuration manager

Start up

1. Click on **Config Mgr** in the control menu. (image 8-1)
The config Manager environment starts up. (image 8-2)



Image 8-1
Control menu

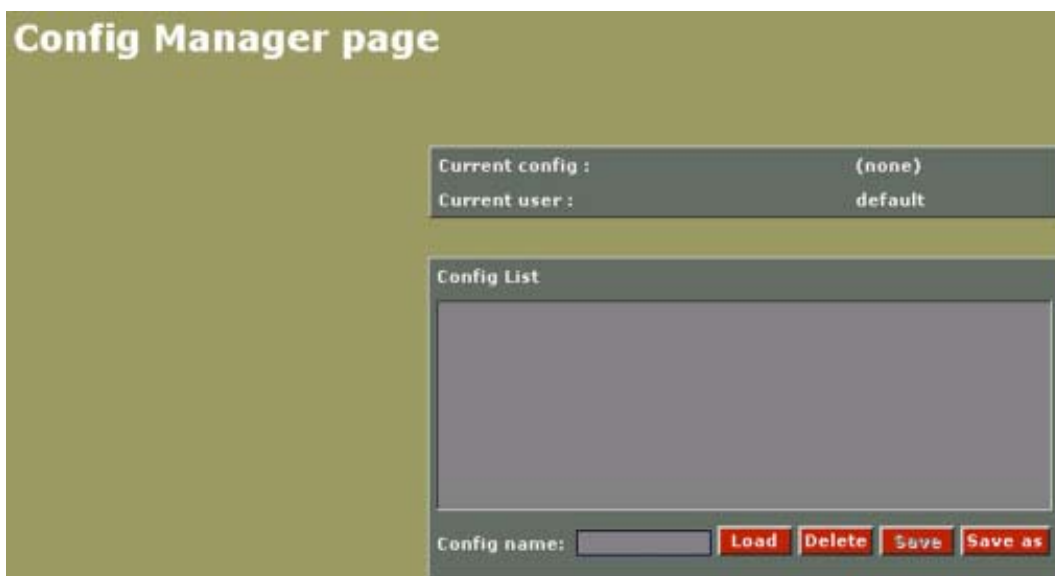

Image 8-2
Configuration manager page

What is a Config Mgr. ?

A Config Mgr is a collection of system settings, that can be saved under a specific config name.

Settings that can be saved by Config manager are:

- All display settings: contrast, gamma
- The display positioning
- The input settings of digitizer
- The digitizer settings (also the selected source)

The current configuration name is visible next to Current config.

The current user is visible next to Current user.

There is also a list of saved configurations, displayed under Config List.

It is possible to Load, Save or Delete a configuration.

8.2 Saving a Configuration

To Save

1. Click on  on the config Mgr page to save the configuration on the same name.

A pop up window will appear. (image 8-3)

2. Fill in a config name

Config name The name of the configuration is already filled in.

Description space to enter a description of this configuration if it should be necessary

3. Click on  to abort the save operation.

Click on  to save the configuration.

If the save is successfully, a confirmation page will be displayed (image 8-4)

4. Click upon the text to return to the config management page.



Image 8-3
Saving a configuration on the same name



Image 8-4
Save OK

8.3 “Save as” a Configuration

To Save as

1. Click on **Save as** on the Configuration Mgr page to save the new configuration on a different name.
A pop up window will appear. (image 8-5)

2. Fill in a config name

Config name you fill in the name of the configuration you want to save.

Description space to enter a description of this configuration if it should be necessary

3. Click on **Cancel** to abort the save as operation.
Click on **Save** to save the configuration.

If the save is successfully, a confirmation page will be displayed (image 8-6)

4. Click upon the text to return to the Config management page.



Image 8-5



Image 8-6

8.4 Deleting a Configuration

To delete

To delete a configuration, follow the next steps:

1. Select a configuration in the list to delete. (image 8-7)
2. Click **Delete**.

A confirmation box appears, asking if this configuration should be deleted or not. (image 8-8)

3. Click **Cancel** to abort.
Click **OK** to continue.

The message 'Style xxx was successfully deleted' will be displayed to confirm the deletion of that specific configuration. (image 8-9)

4. Click upon the text to return to the Configuration management page.
5. To return to the main section page, click **Config Mgr**.

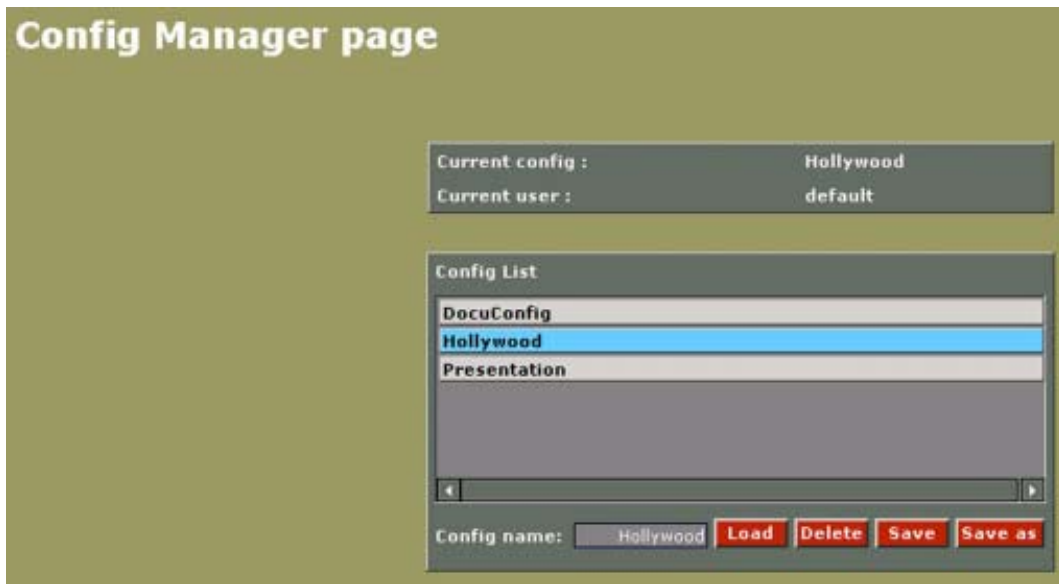

Image 8-7
Select a configuration to delete



Image 8-8

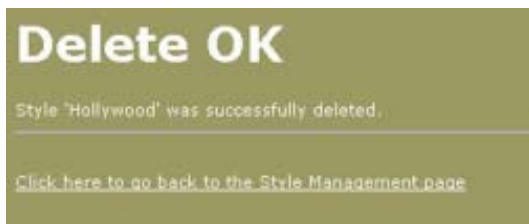

Image 8-9
Delete message

8.5 Loading a Configuration

To load

To load a configuration, handle as follow:

1. Select the configuration in the list with the mouse.
2. Click on **Load** (image 8-10)

Note: *If this configuration is loaded for a non compatible configuration (e.g. device removed) the indication not compatible will be added next to the device. This device will be not selectable.*

The Update Config page will be displayed with the name of the loaded configuration and a description.

In this page you can make your update selection choice. (image 8-11)

3. Make your update selection choice by checking the selection boxes.
The following choices are possible :
 - Digitizer settings
 - Input settings

4. To apply the loaded settings, click the **Apply** button.

During the update, logging information is viewable in the Log Info View window. On completion, a confirmation page is viewable.

5. Click upon the text to return to the Config manager page.

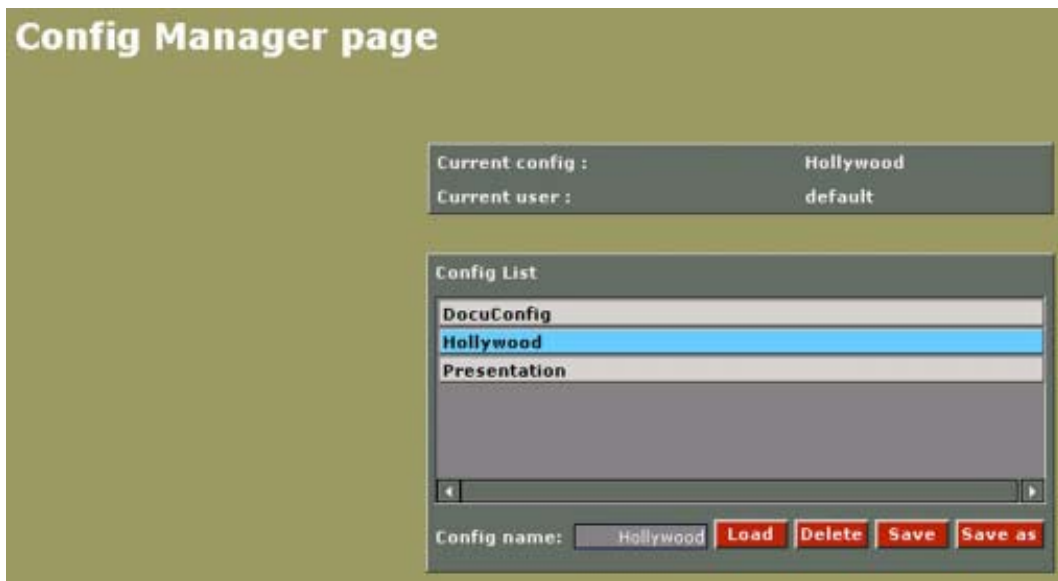

Image 8-10

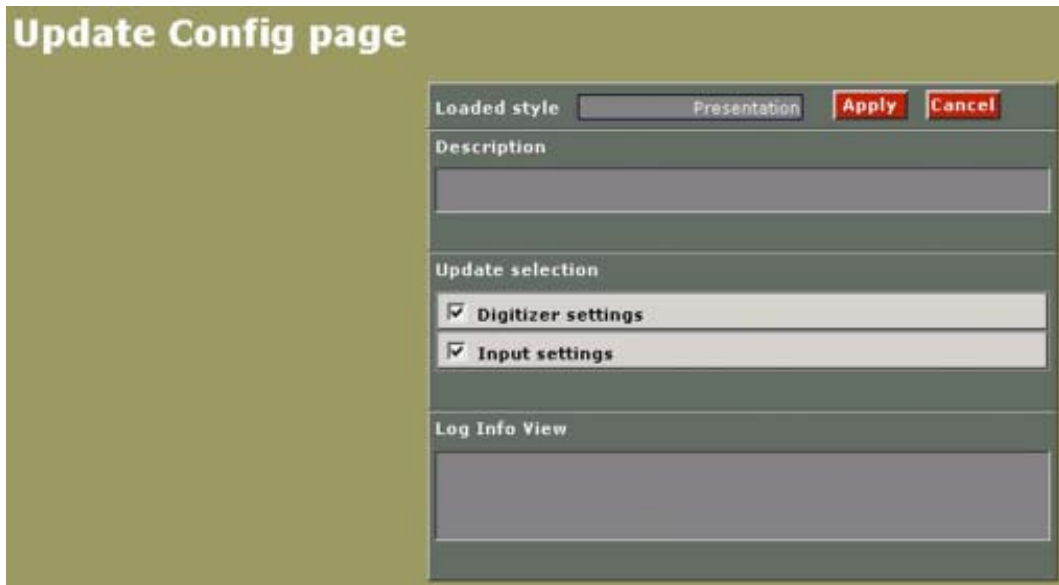

Image 8-11

9. PREFERENCES

Overview

- Purpose of the preferences set up
- Start up the preferences
- Adjusting the window offset
- Changing the Screen position

9.1 Purpose of the preferences set up

Overview

With the preferences set up for each input on each screen, it is possible to fine tune the window positioning per screen.

With the screen position adjustment it is possible to change the position of the screen so that the overlap zone will change too.

9.2 Start up the preferences

To start up

1. Click on **Preferences** in the *Control menu*. (image 9-1)

The *Preferences window* opens. (image 9-2)



Image 9-1
Select Preferences

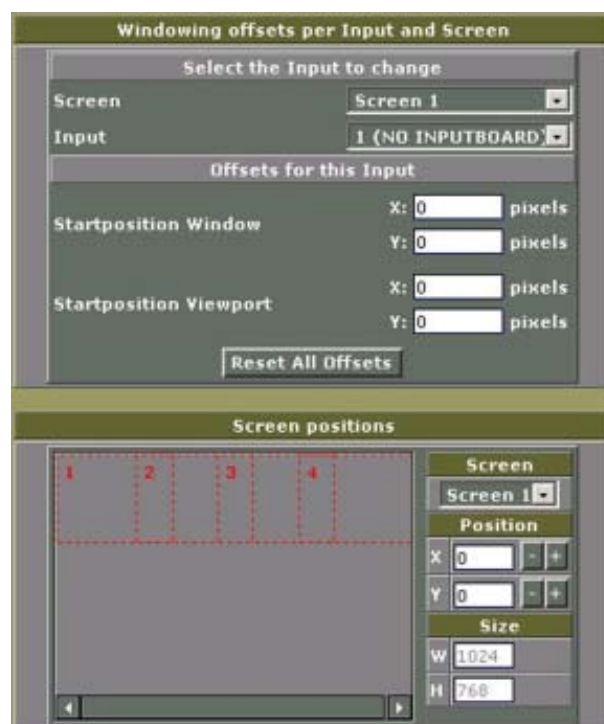

Image 9-2
Preferences window

9.3 Adjusting the window offset

How to adjust.

1. Select a screen by clicking on the drop down box next to *Screen*. (image 9-3)
2. Select an input which is displayed on the selected screen.
3. Adjust the offset start position (X and Y coordinate) for the window and the viewport by clicking in the input field and entering the value with the keyboard.

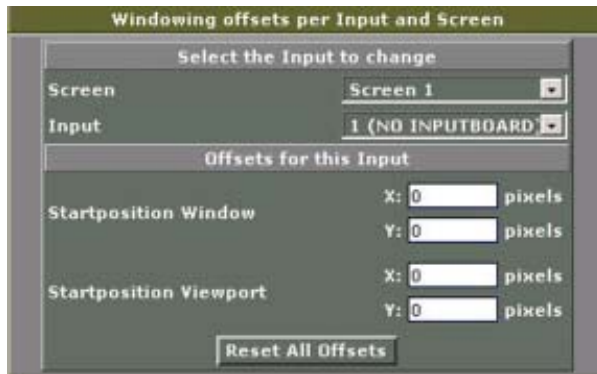

Image 9-3
Window offset

Reset the offset

1. Click on **Resets All Offsets**.
All offset values will be resetted to zero.

9.4 Changing the Screen position

How to adjust

1. Select a screen by clicking on the drop down box below *Screen*. (image 9-4)
The actual position will be indicated next to X and Y.
2. Click in the X or Y input field and enter the desired value.
The visual screen representation will change accordingly.

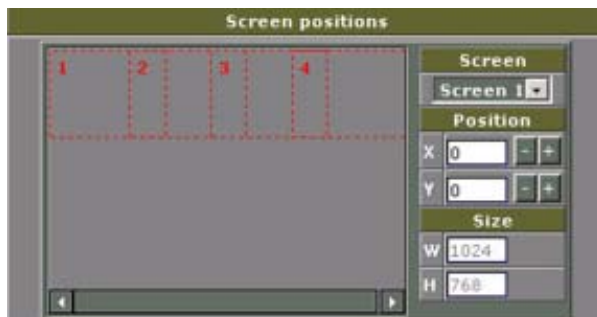

Image 9-4
Screen position

10. VIEWSCAPE CONFIGURATION

Overview

- ViewScape Configuration start up
- ViewScape Settings

10.1 ViewScape Configuration start up

Start up

1. Click the ViewScape icon to reveal the following pop menu for the selected screen in the display. (image 10-1)

Note: Lay out of configuration windows depends on the Output Selection choice.

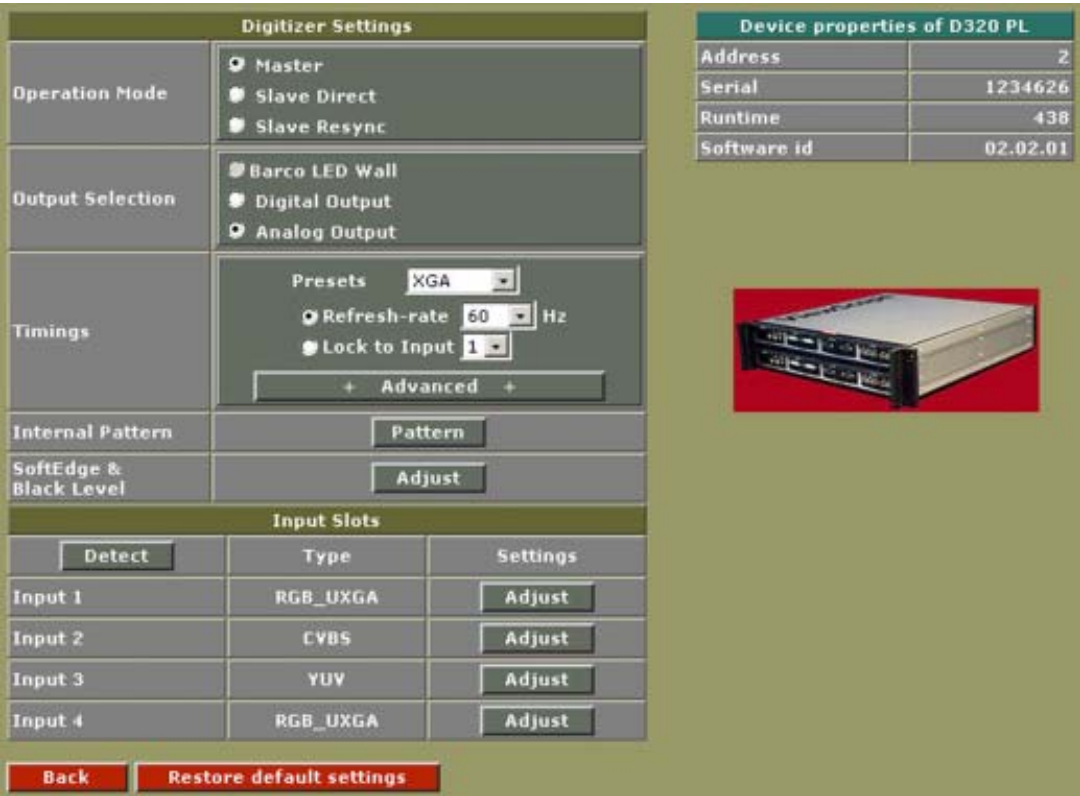

Image 10-1
Configuration window ViewScape, digital or analog output selected



To restore the default settings, click on **Restore default settings** button.

10.2 ViewScope Settings

10.2.1 Operational Mode

Overview

3 operation modes are possible:

- Master : the addressed device is the first in a chain of multiple devices.
- Slave Direct
- Slave Resync



Image 10-2



Image 10-3



Image 10-4

Example

Without background or with overlapped background

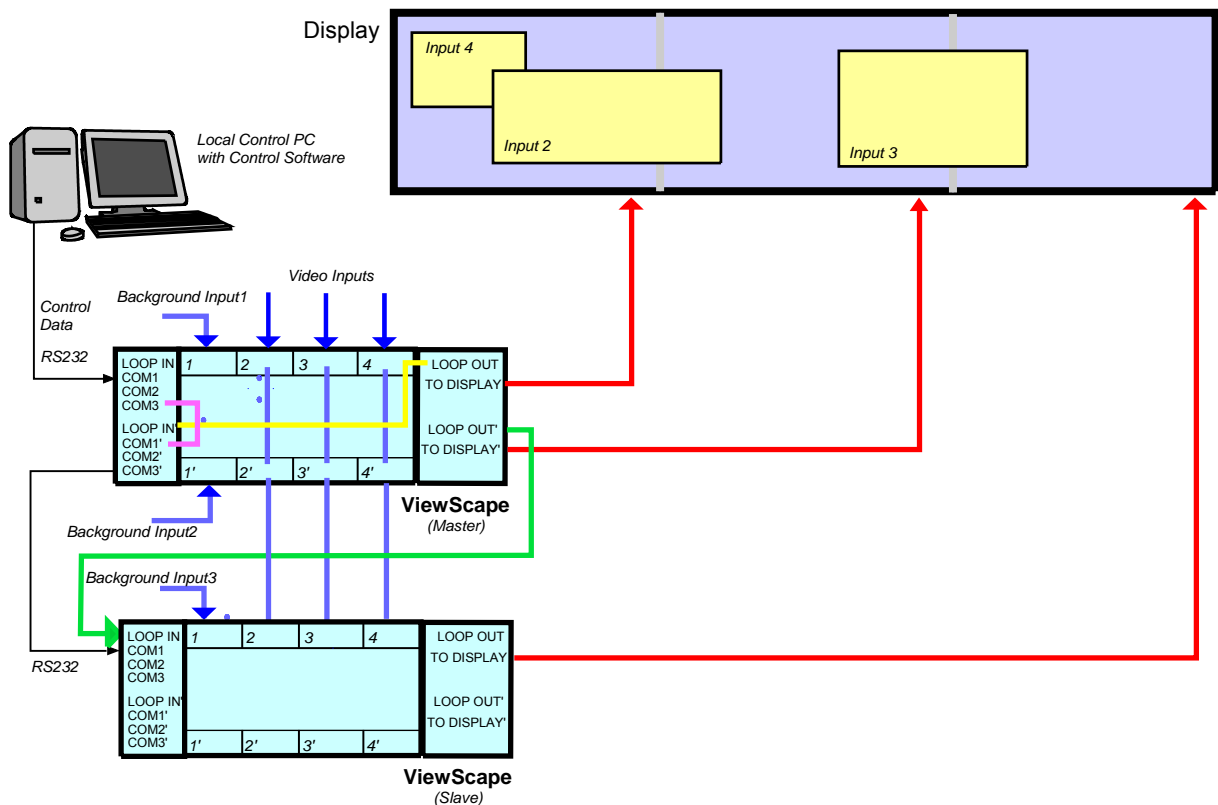

Image 10-5
ViewScope configuration

With Multiple 'independent' (hard edged) background

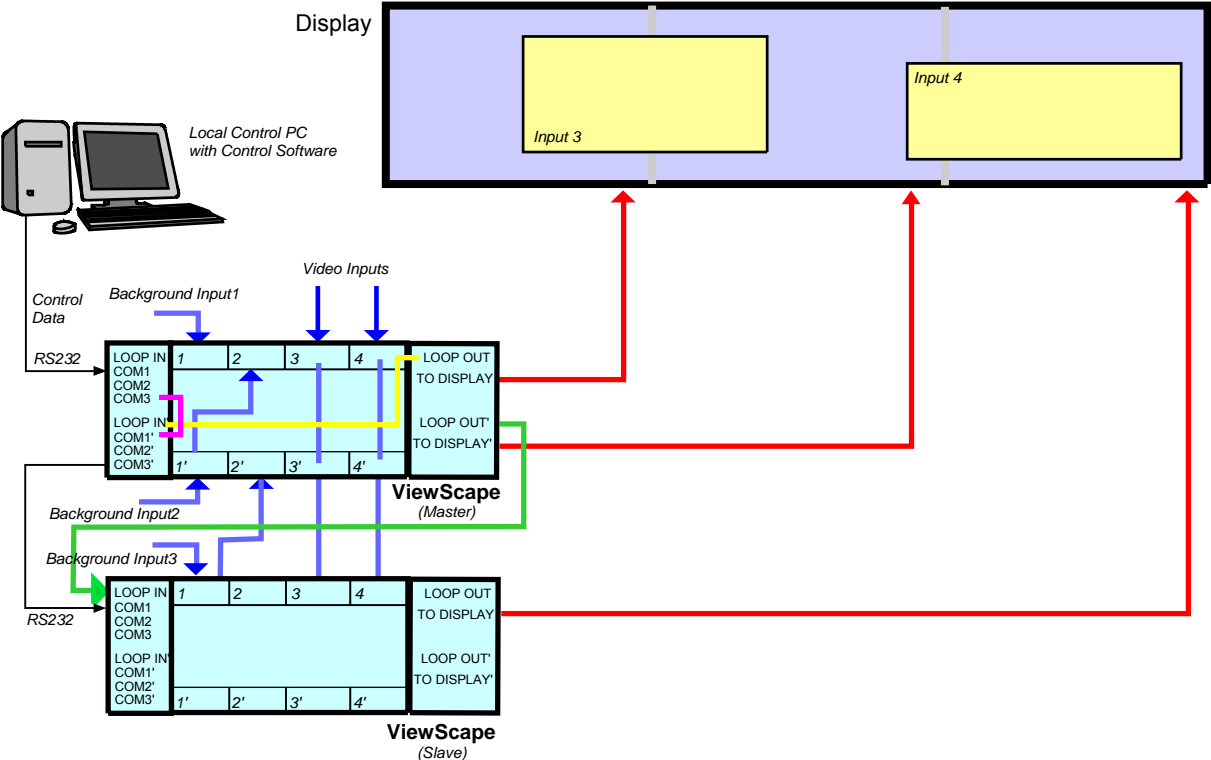

Image 10-6
ViewScape configuration with independent (hard edged) background

10.2.2 Output Selection

Overview

3 different outputs are possible:

- Barco LED Wall (not active for ViewScape).
- Digital Output, can be used by any display device which has a digital input.
- Analog Output, can be used by any display device which has an analog input.

10.2.3 Timings

Overview

- Using predefined timings for digital or analog output
- Using the advanced timing settings for digital or analog output
- Timings of Sync Generator for Digital or Analog output
- Timings of Display Interface for Digital or Analog output

10.2.3.1 Using predefined timings for digital or analog output

How to select

1. Click on the drop down box. (image 10-7)
2. Select the corresponding setting.
The following settings are possible
 - SVGA
 - XGA
 - SXGA
 - SXGA+
 - UXGA
3. Make your choice between manual selected refresh rate (50 or 60 Hz) and lock to input (only the inputs of the master can be selected).



Image 10-7
Selecting a preset timing

10.2.3.2 Using the advanced timing settings for digital or analog output

How to select

1. Select first a predefined setting, see "Using predefined timings for digital or analog output", page 86.
2. Click on **- Advanced -**.

The timings menu expands. (image 10-8)

Different timing settings are available for:

Analog output	Sync generator and display interface timings are available
Digital output	Only sync generator timings are available

3. Click on **Timings** next to *Sync Generator*.

The Sync Generator timing window reveals. (image 10-9)

For more explanation see "Timings of Sync Generator for Digital or Analog output", page 88.

4. Click on **Timings** next *Display Interface*.

The Display Interface timings window reveals. (image 10-10)

For more explanation see "Timings of Sync Generator for Digital or Analog output", page 88

5. Check *Frame Rate Conversion* when you are working with CRT projectors.

When checked, it generates a continuous sync with delay.

This *Frame Rate Conversion* option exclude the *Lock on HSync*.

6. Check *Lock on HSync* in all other cases, especially when working with moving images.

When checked, it generates discontinued sync with minimal delay. It avoids shaking images.

This *Lock on HSync* option exclude the *Frame Rate Conversion*.

7. Horizontal sync polarity can be positive or negative. The position depends on the display.

- 8. Vertical sync polarity can be positive or negative. The position depends on the display.
- 9. You have checked *Lock on input* ?
If yes, then adapt the frame delay in lines until the full image is displayed.



Image 10-8
Advanced Timings menu

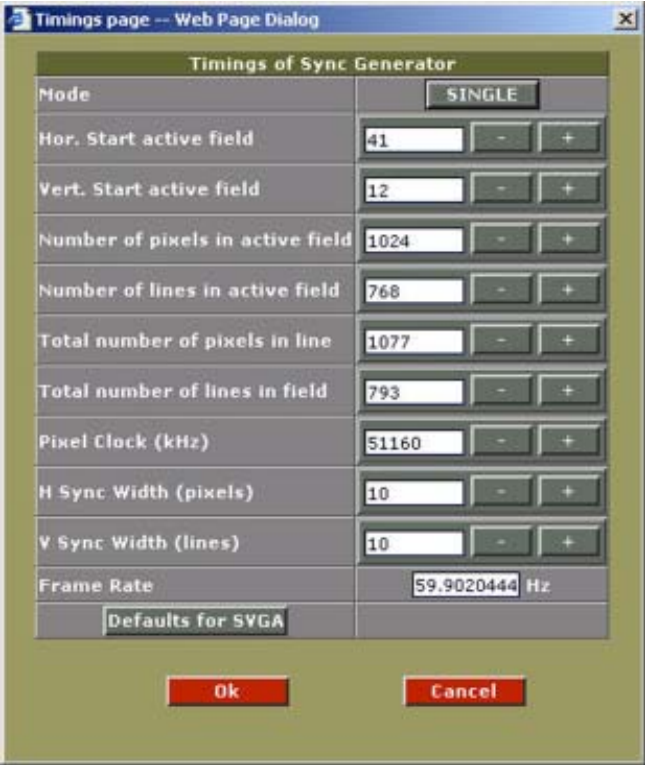

Image 10-9
Sync generator timing window

10. ViewScape Configuration

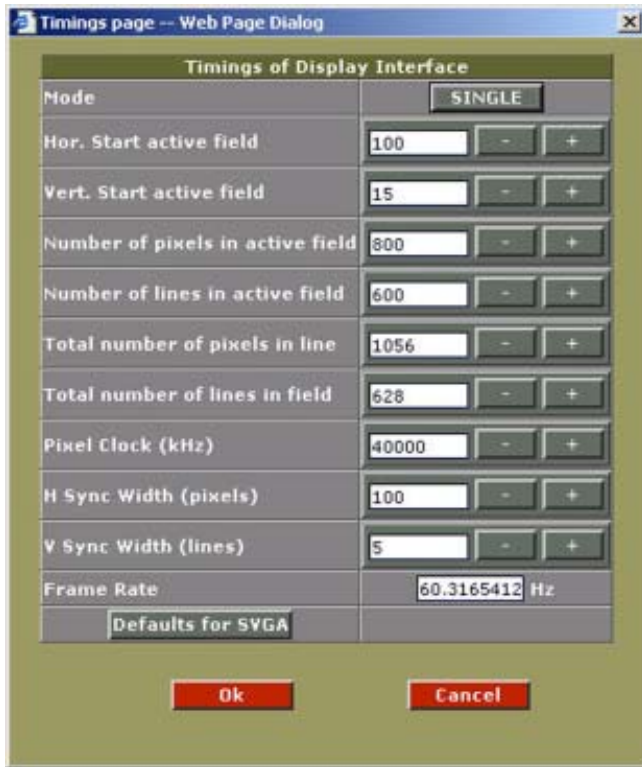

Image 10-10
Display Interface timings window



Tune last line length : only active if *Frame rate conversion* and *H sync lock* are not checked. In some situation the last image line is not a full line and causes a locking problem so that no image is visible. When that happens, push the button Tune last line and the clock will be tuned so that the last line becomes as long as the other lines.

10.2.3.3 Timings of Sync Generator for Digital or Analog output



The values which are filled in are the default values for the selected preset.

Schematic overview

Hor. line

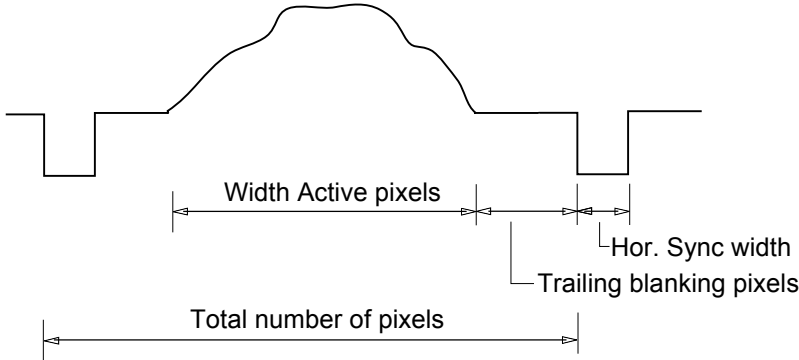

Field

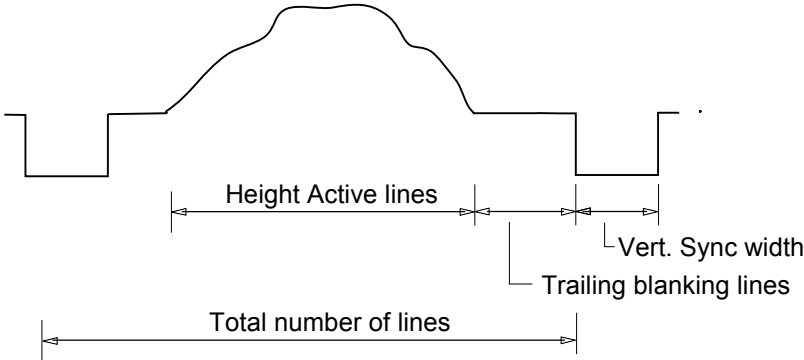

Image 10-11
Explanation of the terms

Mode

The pixel clock can work in 2 ways: single or dual path. This toggle button makes it possible to change the clock mode.



Working in dual path doubles the pixel clock speed.

Horizontal Start Active Pixels

The horizontal start position of the active image area, referenced from HSync. The value must be greater than Hsync Width.



Image 10-12

Vertical Start Active Pixels

The vertical start position of the active image area, referenced from VSync. The value must be greater than Vsync Width.

Width active pixels

The number of pixels that are really used (= the actual width of the image/video that will be shown).

Height active pixels

The number of lines that are really used (= actual height of the image/video that will be shown).

Total number of pixels in line.

The total number of pixels in a line (= max. width).

total= (hor. Start active pixels) + (width active pixels) + (number of trailing blanking pixels).

Total number of lines in field.

The total number of lines in a field (= max height).

total=(vert. Start active pixels) + (height active pixels) + (number of trailing blanking lines)

Pixel Clock (kHz)

The clock speed of the digitizer. Typically, this will be 32 MHz (in single mode)

H Sync Width

The width of the horizontal sync signal. This should always be 10 pixels.

V Sync Width

The width of the vertical sync signal. This should always be 10 pixels.

Frame Rate

Vertical frequency of the input signal.

Defaults for the selected preset

To return to the defaults for the selected preset, press **Defaults for xxxx**. Where xxxx is the value entered in the presets input field.

10.2.3.4 Timings of Display Interface for Digital or Analog output



The values which are filled in are the default values for the selected preset.

Mode

The pixel clock can work in 2 ways: single or dual path. This toggle button makes it possible to change the clock mode.



Working in dual path doubles the pixel clock speed.

Horizontal Start Active Pixels

The horizontal start position of the active image area, referenced from HSync (number of pixels between the beginning of the input signal and the start of the video information). The value must be greater than Hsync Width.

Vertical Start Active Pixels

The vertical start position of the active image area, referenced from VSync (number of lines between the start of the input signal and the start of the image on the screen). The value must be greater than Vsync Width.

Width active pixels

The number of pixels that are really used (= the actual width of the image/video that will be shown) This value is normally given in the source specifications. If not, adjust until full image is displayed (no missing pixels).

Height active pixels

The number of lines that are really used (= actual height of the image/video that will be shown). This value is normally given in the source specifications. If not, adjust until full image is displayed (no missing lines).

Total number of pixels in line.

The total number of pixels in a line (= max. width).

total= (hor. Start active pixels) + (width active pixels) + (number of trailing blanking pixels).

Total number of lines in field.

The total number of lines in a field (= max height).

total=(vert. Start active pixels) + (height active pixels) + (number of trailing blanking lines)

Pixel Clock (kHz)

The clock speed of the processing unit.

H Sync Width

The width of the horizontal sync signal.

V Sync Width

The width of the vertical sync signal.

Frame Rate

Vertical frequency of the input signal.

Defaults for the selected preset

To return to the defaults for the selected preset, press **Defaults for xxxx**. Where xxxx is the value entered in the presets input field.

10.2.4 Pattern Generation**Overview**

- Overview and activation
- Test pattern set up

10.2.4.1 Overview and activation**Overview**

The digitizer can generate patterns for testing purposes.

Different available patterns are:

- Bytelevel : a one color pattern
- Crosshatch
- HRamp : horizontal bars
- Multiburst : pixel on, pixel off pattern
- Blocks : block pattern
- VRamp : vertical bars

10. ViewScape Configuration

Use the 'pattern' button to go to the pattern page. On this page you can activate the pattern generation and change the pattern settings.

How to activate test patterns

1. Click on **Pattern** to activate the test pattern generator.

The test pattern generator window opens. (image 10-13)

2. Toggle the status by clicking on the ON/OFF button.
 - ON : test pattern will be generated
 - OFF : no test pattern will be generated



Image 10-13
Test pattern generator window

10.2.4.2 Test pattern set up

How to configure a test pattern

1. Click on of the 6 available patterns.

The name of the selected pattern will be displayed in the box *Current pattern*. (image 10-14)

Depending on the selected pattern, an extra input box appears.

Pattern	Extra input box
Bytelevel	Amplitude: the amplitude (brightness) of the pattern.
Crosshatch	Pixelwidth: the width of the pixels (lines). Value between 1 and 4.
HRamp	no extra input box
Multiburst	Type: type of the multiburst pattern (width of the pixels). Can be a value between 0 and 7.
Blocks	no extra input box
VRamp	no extra input box

2. Select the color that will be used to generate the pattern.

The following options are possible:

- Red
- Green
- Blue
- Yellow (R + G)
- Cyan (G + B)
- Magenta (R + B)
- White (R+ G + B)
- Loop all

Select 'LOOP ALL' to loop through all the available colors.

3. If the pattern has to move over the screen, check Vertical and/or horizontal and select the direction.

Note: Only available for 'Crosshatch', 'HRamp' and 'VRamp' patterns.

Note: Important to avoid a burn in.



Image 10-14
Pattern choices

10.2.5 Soft Edge and Black level adjustment

Overview

- Overview and activation
- Soft Edge Settings
- Black level adjustment

10.2.5.1 Overview and activation

Overview

The digitizer can generate a seamless transition between two screens so that no effects are visible on the display.

A pattern can be used to make the adjustment more easy.

How to start up

1. Click on **Adjust** next to *SoftEdge & Black level* adjustment. (image 10-15)

The soft edge & black level adjustment window opens. (image 10-16)



Image 10-15
Start up soft edge & black level

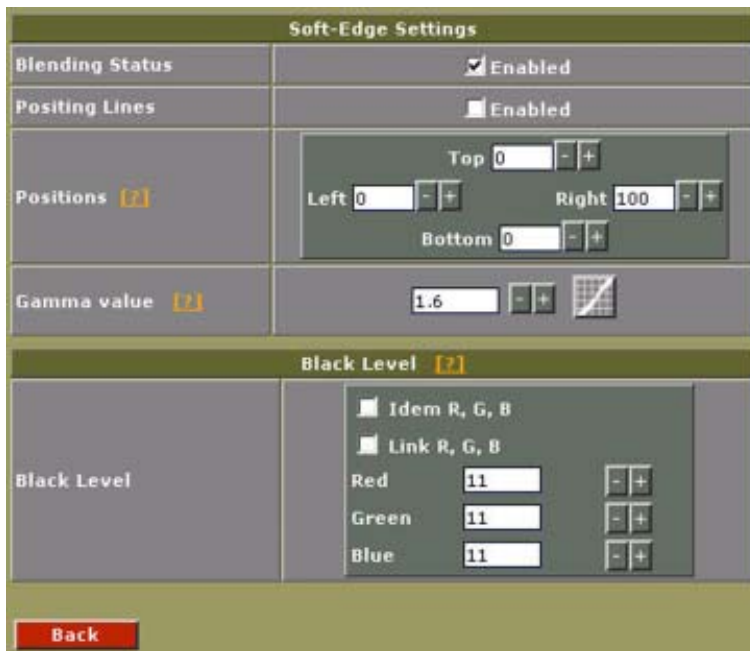

Image 10-16
Soft Edge settings and black level adjustment

10.2.5.2 Soft Edge Settings

How to set up

1. Enable the blending status by checking the check box.
2. Do you want to use positioning lines?
If yes, Check the box enabled next to Positioning lines.

A pattern with the different areas will be displayed. (image 10-17)

If no, go to step 3

3. Set the values for Left, Right, Top and Bottom until the border of the overlap area is in the desired position (value between 0 and 255). Set first the width for the first projector and repeat for the second one. (image 10-18, image 10-19)

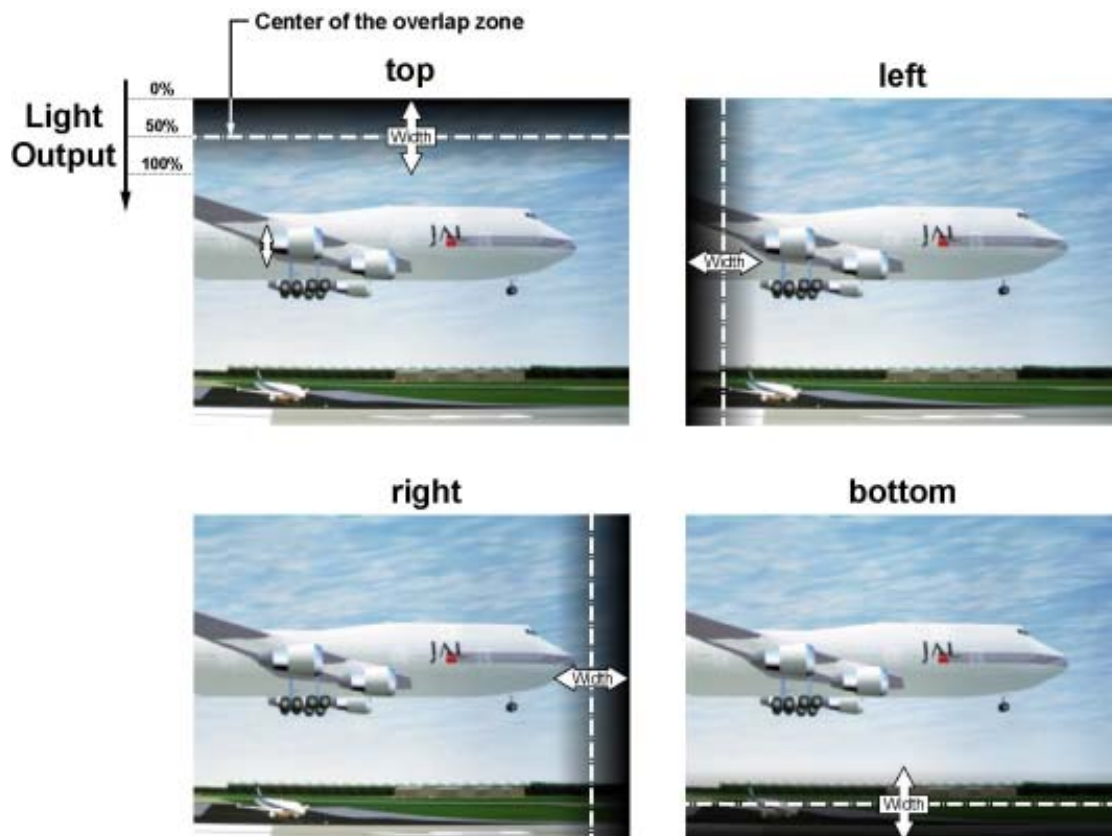

Image 10-17

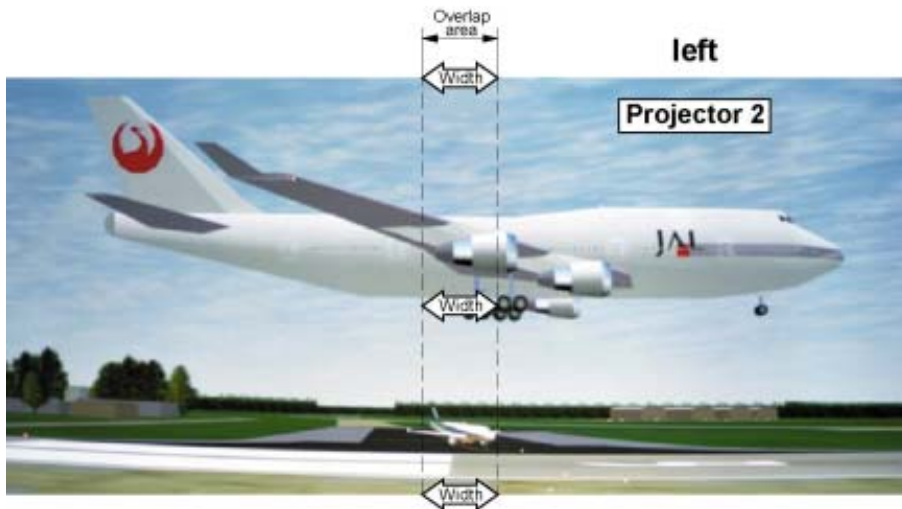

Image 10-18

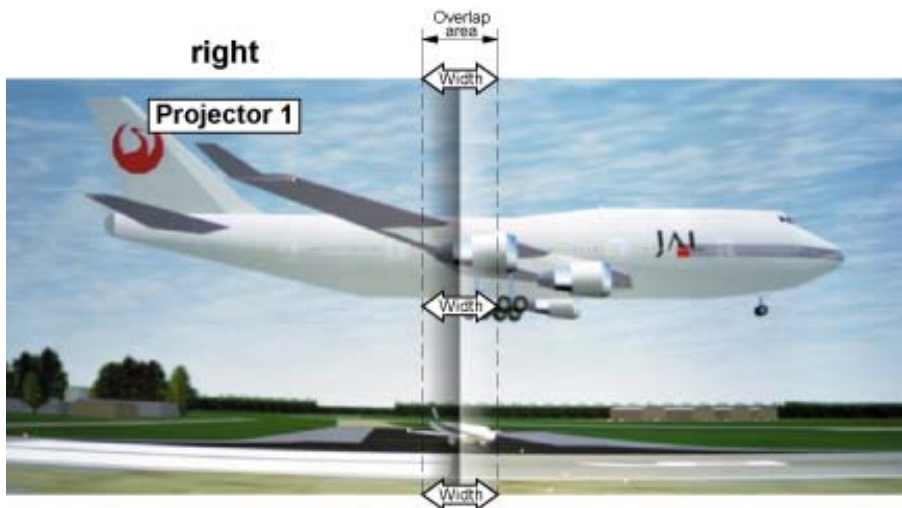

Image 10-19

Gamma value

1. Set the gamma value the same as the gamma value of the projector.

10.2.5.3 Black level adjustment

What should be done

For dark images, the overlap zone will be brighter than the rest of the image. Therefore, increment the black level of the non overlapped zones until the result is the same with the overlap zone.

Adjustment

1. Do you want to have the same value for Red, Green and Blue.
If yes, Check the check box next to *Item R, G, B*. Go to step 3.
2. Do you want to increment Red, Green and Blue with the same value?
If yes, Check the check box next to *Link R, G, B*. Go to step 3.
3. Increment the value for Red, Green and Blue until the black level in the unoverlapped zone is the same as the black level in the overlapped zone.
4. Click  to return to the digitizer settings.

11. INPUT SLOTS FOR VIEWSCAPE

Overview

- General info
- Input D320 DVI-D
- Input D320 YUV/RG(s)B
- Input D320 SDI
- Input D320 HDSDI
- Input D320 CVBS/S-Vid
- Input D320 RGB analog
- Input D320 RGB analog (UXGA)



Check the **Apply Level Settings** before starting any adjustment on the inputs. For more info about apply level settings, see "Display selection", page 42.

11.1 General info

Refresh/update input detection

1. Click  on the Input slots part of the configuration screen to update/refresh the input detection process. (image 11-1)

Note: Only use the detect button when new input slots are inserted.

A confirmation window will be shown. (image 11-2)

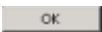
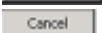
2. Click  to proceed.
Click  to abort.

Input Slots			
	Type	Firmware	Settings
Input 1	SDI	01.00	
Input 2	YUV	02.00	
Input 3	HDSDI	01.01	
Input 4	DVI	01.06	

Image 11-1



Image 11-2

Type of inputs

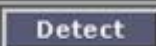
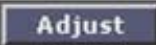
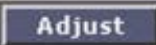
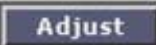
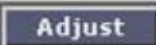
Input types and the input port they are connected to in accordance to the front of the D320 will be indicated.

11. Input Slots for ViewScape

The following inputs are available for the D320:

- DVI
- YUV/RG(s)B
- SDI
- CVBS/S-Vid
- RGB analog (SXGA)
- RGB analog (UXGA)

Clicking **Adjust** against any specific input will give access to that inputs adjustment parameter window.

11.2 Input D320 DVI-D

11.2.1 Settings start up



DVI

Digital Visual Interface. DVI is a high speed serial display interface developed in response to the proliferation of digital flatpanel displays.

How to start up

1. Click **Adjust** against DVI input on the Input Slots part of the menu gives the DVI parameter window. (image 11-3)
2. Click on the **Back** to return to the general D320 window.
3. Click on **Restore default settings** to restore the default settings.



Image 11-3
Setting DVI input slot D320

What can be adjusted?

This window consists out of 3 parts:

- Image processing
- Frequency reclock
- RGB Contrast

11.2.2 Image Processing

Refresh Rate DDC

Configure the DVI with VESA standard. There are five selectable resolution setup values that can be recognized by the graphic card through DDC communication.

VGA	85Hz refresh rate
SVGA	60Hz refresh rate
XGA	60Hz refresh rate
SXGA	60Hz refresh rate
UXGA	60Hz refresh rate

The graphic card will boot up in the selected display mode as far as the selected display mode is within the card's capabilities.

Pixel Select

Single/dual pixel mode. 24bits/48bits.

Set always in "Single" for VGA, SVGA.

Set always in "Dual" for XGA, SXGA and UXGA.

11.3 Input D320 YUV/RG(s)B

11.3.1 Settings start up

How to start up

1. Click **Adjust** against YUV/RG(s)B input on the Input Slots part of the menu gives the YUV/RG(s)B parameter window. (image 11-4)
2. Click on the **Back** to return to the general D320 window.
3. Click on **Restore default settings** to restore the default settings.



Image 11-4
Settings YUV/RG(s)B input slot D320

What can be adjusted?

This window consists out of 3 parts:

- Image processing
- Video Equalizing
- RGB Contrast

11.3.2 Image Processing

Saturation

Adjustable from 0 to 15 with the corresponding slider.

Saturation is the intensity of the color, 0 will be black & white.

Brightness

Adjustable from 0 to 63 with the corresponding slider.

Brightness is the intensity of the displayed signal.

Brightness will add or subtract ... to the luminance part of the signal.

Contrast

Adjustable from 0 to 127 with the corresponding slider.

Contrast is digital signal level alignment of the input signal.

Luma Tracking

Adjustable from 0 to 15 with the corresponding slider.

Luma Tracking adjusts the level of green haze appearing in the low lights.

Clip to Subblack

Adjustable from 0 to 15 with the corresponding slider.

Clip To Subblack will filter spurious LSB's in low lights under black-level, to prevent that spurious pixels appear in black planes, even after Dynamic Image Stabilization.

De-interlacing Mode

Select between Median/Filmmode or Line Repetition.

The *Median/Filmmode* is effective when the source signal has interlaced fields between frames.

The *Line Repetition* is effective for a non-interlace field sources (static images). The lines of the odd field will be doubled to obtain a complete image.

For normal video, Median/Filmmode should be selected.

Filmmode

Toggle between ON/OFF for either switching the Filmmode on or off.

Select ON to enable 2 to 2/3 to 2 pull down processing....

Select OFF to force the processing to normal ...

Film Detection Sensitivity

Select the level at which the filtered response for film content should be driven at. Useful for noisy video content.

Film Detection Threshold

Select the level at which the film detection and processing is activated. Four levels exist. Useful for noisy video content.

Freeze

Freezes the content of this source only.

Color Matrix

Select a Color Matrix suitable for the material being viewed:

- AUTO Automatic adapted to incoming source, depending on measured raster frequency
- EBU European Standard (PAL/SECAM)
- ANSI American Standard (NTSC)

Video Feed

Two possible choices:

- YUV
- RGsB

Select the input type which has to be displayed.

Banner Protect

Banner protect ON or OFF. Is only effective when Filmmode detection is in the ON position.

With banner protect ON, the bottom 1/4 of the lines will not be processed in Filmmode detection. That avoid scrolling banners or "ticker tapes" causing FILM mode errors.

Color Transient Improvement (CTI)

CTI sharpen the transient between two next to each other projected colors. The degree of improvement can be adjusted with the slider bar.

When on 0, the image is displayed without CTI. 7 represents the sharpest CTI.

Luma Transient Improvement (LTI)

LTI accentuates the transient between two parts of the image with different intensity. The degree of improvement can be adjusted with the slider bar.

When on 0, the image is displayed without LTI. 7 represents the sharpest LTI.

Field Insert

Field insert can be ON or OFF.

With *Field Insert* ON, both fields of a interlaced image will be added together to form one de-interlaced image.

When Field insert is ON, the De-Interlacing mode has no function.

11.3.3 Input Gain Equalizing

Overview

Each gain can be adjusted between 0 and 255 (-3dB and +6dB).

Any value can be entered by

- clicking first in digit box and entering the desired value or
- sliding the corresponding slider to the desired value.

3 values, -3dB, 0dB, +6dB or preprogrammed and can be selected by clicking on the corresponding indication.

The slider jumps immediately to correct value.

The following input gain adjustments are possible:

- Luminance Gain
- V-Gain
- U-Gain

11.3.4 Dynamic Image Stabilizer (DIS)

Value

between 0 and 7.

Slide

magnified/normal.

Magnified for DIS effectivity. Useful for noisy video content.

Flash

ON/OFF

To compensate for fast moving images, the DIS Flash will detect such movements and put the DIS temporary off.

DIS sensitivity

Select the amplitude sensitivity of the DIS

For low video quality sources choose Luma Low/ Chroma Low for video sources of high quality choose Luma High/ Chroma High (preferable)

DIS filter

Select the frequency sensitivity of the DIS

For low video quality sources choose Luma On/ Chroma On (preferable) for video sources of high quality choose Luma Off/ Chroma Off

11.3.5 Video Equalizing

Overview

Adjustment of the sharpness impression of the image in three frequency ranges (low, medium, high). Adjust sharpness completely conform own preferences or use predefined preset.

11.4 Input D320 SDI



SDI

Serial Digital Interface

11.4.1 Settings start up

How to start up

1. Click **Adjust** against SDI input on the Input Slots part of the menu gives the SDI parameter window. (image 11-5)
2. Click on the **Back** to return to the general D320 window.
3. Click on **Restore default settings** to restore the default settings.



Image 11-5
Settings SDI input slot D320

What can be adjusted?

This window consists out of 3 parts:

- Image processing
- Video Equalizing
- Dynamic Image Stabilizer

11.4.2 Image Processing

Saturation

Adjustable from 0 to 15 with the corresponding slider.

Saturation is the intensity of the color, 0 will be black & white.

Brightness

Adjustable from 0 to 63 with the corresponding slider.

Brightness is the intensity of the displayed signal.

Brightness will add or subtract ... to the luminance part of the signal.

Luma Tracking

Adjustable from 0 to 15 with the corresponding slider.

Luma Tracking adjusts the level of green haze appearing in the low lights.

Clip to Subblack

Adjustable from 0 to 15 with the corresponding slider.

Clip To Subblack will filter spurious LSB's in low lights under black-level, to prevent that spurious pixels appear in black planes, even after Dynamic Image Stabilization.

Internal Mode

Select between Median/Filmmode or Line Repetition.

The first is effective when the source signal has interlaced fields between frames.

The second is effective for a non-interlace field sources.

For normal video, Median/Filmmode should be selected.

De-interlacing Mode

Select between Median/Filmmode or Line Repetition.

The *Median/Filmmode* is effective when the source signal has interlaced fields between frames.

The *Line Repetition* is effective for a non-interlace field sources (static images). The lines of the odd field will be doubled to obtain a complete image.

For normal video, Median/Filmmode should be selected.

Film Detection Sensitivity

Select the level at which the filtered response for film content should be driven at. Useful for noisy video content.

Film Detection Threshold

Select the level at which the film detection and processing is activated. Four levels exist. Useful for noisy video content.

Freeze

Freezes the content of this source only.

Color Matrix

Select a Color Matrix suitable for the material being viewed:

- AUTO Automatic adapted to incoming source, depending on measured raster frequency
- EBU European Standard (PAL/SECAM)
- ANSI American Standard (NTSC)

Banner Protect

Banner protect ON or OFF. Is only effective when Filmmode detection is in the ON position.

With banner protect ON, the bottom 1/4 of the lines will not be processed in Filmmode detection. That avoid scrolling banners or "ticker tapes" causing FILM mode errors.

Color Transient Improvement (CTI)

CTI sharpen the transient between two next to each other projected colors. The degree of improvement can be adjusted with the slider bar.

When on 0, the image is displayed without CTI. 7 represents the sharpest CTI.

Luma Transient Improvement (LTI)

LTI accentuates the transient between two parts of the image with different intensity. The degree of improvement can be adjusted with the slider bar.

When on 0, the image is displayed without LTI. 7 represents the sharpest LTI.

Field Insert

Field insert can be ON or OFF.

With *Field Insert* ON, both fields of a interlaced image will be added together to form one de-interlaced image.

When Field insert is ON, the De-Interlacing mode has no function.

11.4.3 Dynamic Image Stabilizer (DIS)

Value

between 0 and 7.

Slide

magnified/normal.

Magnified for DIS effectivity. Useful for noisy video content.

Flash

ON/OFF

To compensate for fast moving images, the DIS Flash will detect such movements and put the DIS temporary off.

DIS sensitivity

Select the amplitude sensitivity of the DIS

For low video quality sources choose Luma Low/ Chroma Low for video sources of high quality choose Luma High/ Chroma High (preferable)

11. Input Slots for ViewScape

DIS filter

Select the frequency sensitivity of the DIS

For low video quality sources choose Luma On/ Chroma On (preferable) for video sources of high quality choose Luma Off/ Chroma Off

11.4.4 Video Equalizing

Overview

Adjustment of the sharpness impression of the image in three frequency ranges (low, medium, high). Adjust sharpness completely conform own preferences or use predefined preset.

11.5 Input D320 HDSDI

11.5.1 Settings start up

How to start up

1. Click **Adjust** against HDSDI input on the Input Slots part of the menu gives the HDSDI parameter window. (image 11-6)
2. Click on the **Back** to return to the general D320 series window.
3. Click on **Restore default settings** to restore the default settings.

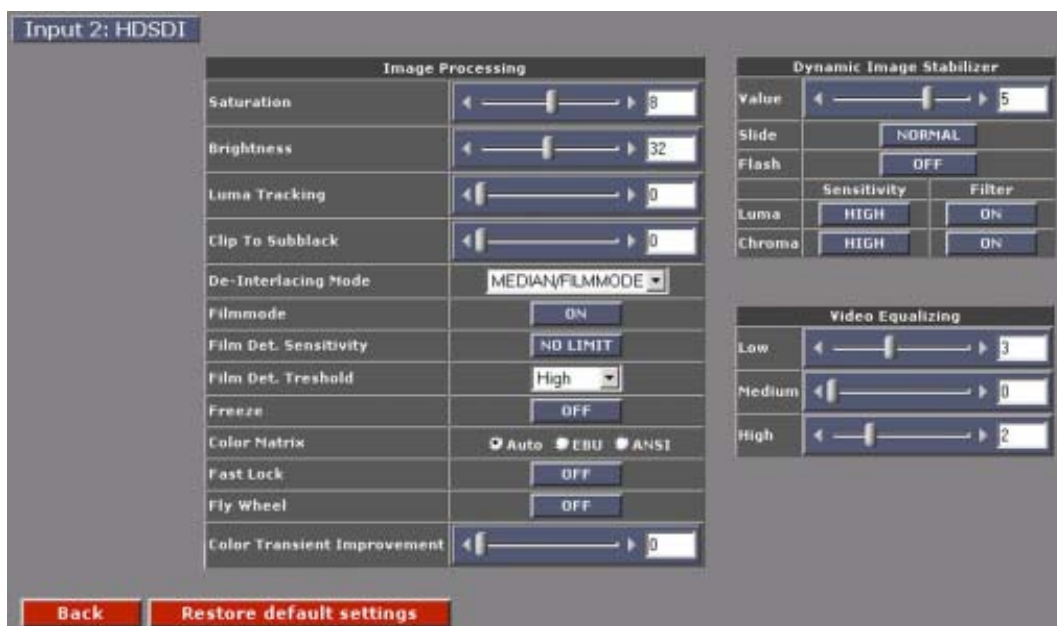

Image 11-6
Setting HDSDI input slot for D320 series

What can be adjusted?

This window consists out of 3 parts:

- Image processing
- Video Equalizing
- Dynamic Image Stabilizer

11.5.2 Image Processing

Saturation

Adjustable from 0 to 15 with the corresponding slider.

Saturation is the intensity of the color, 0 will be black & white.

Brightness

Adjustable from 0 to 63 with the corresponding slider.

Brightness is the intensity of the displayed signal.

Brightness will add or subtract ... to the luminance part of the signal.

Luma Tracking

Adjustable from 0 to 15 with the corresponding slider.

Luma Tracking adjusts the level of green haze appearing in the low lights.

Clip to Subblack

Adjustable from 0 to 15 with the corresponding slider.

Clip To Subblack will filter spurious LSB's in low lights under black-level, to prevent that spurious pixels appear in black planes, even after Dynamic Image Stabilization.

Internal Mode

Select between Median/Filmmode or Line Repetition.

The first is effective when the source signal has interlaced fields between frames.

The second is effective for a non-interlace field sources.

For normal video, Median/Filmmode should be selected.

Filmmode

Toggle between ON/OFF for either switching the Filmmode on or off.

Select ON to enable 2 to 2/3 to 2 pull down processing....

Select OFF to force the processing to normal ...

Film Detection Sensitivity

Select the level at which the filtered response for film content should be driven at. Useful for noisy video content.

Film Detection Threshold

Select the level at which the film detection and processing is activated. Four levels exist. Useful for noisy video content.

Freeze

Freezes the content of this source only.

Color Matrix

Select a Color Matrix suitable for the material being viewed:

- AUTO Automatic adapted to incoming source, depending on measured raster frequency
- EBU European Standard (PAL/SECAM)
- ANSI American Standard (NTSC)

Fast Lock

Way of locking of the PLL of the sync generator.

Default position : ON

When interference is visible on the image, switch to OFF. If the image is not yet improved, continue to Fly Wheel and switch also to OFF.

Fly Wheel

To continue the locking of the PLL of the sync generator when a lock pulse is missing.

Default position : ON

When interference is still visible in the image after Fast Lock is switched off, switch off Fly Wheel too.

Color Transient Improvement

To improve the transition from one color to another.

Adjustable between 0 and 7. With 0 less improvement and 7 the highest improvement.

11.5.3 Dynamic Image Stabilizer (DIS)

Value

between 0 and 7.

Slide

magnified/normal.

Magnified for DIS effectivity. Useful for noisy video content.

Flash

ON/OFF

To compensate for fast moving images, the DIS Flash will detect such movements and put the DIS temporary off.

DIS sensitivity

Select the amplitude sensitivity of the DIS

For low video quality sources choose Luma Low/ Chroma Low for video sources of high quality choose Luma High/ Chroma High (preferable)

DIS filter

Select the frequency sensitivity of the DIS

For low video quality sources choose Luma On/ Chroma On (preferable) for video sources of high quality choose Luma Off/ Chroma Off

11.5.4 Video Equalizing

Overview

Adjustment of the sharpness impression of the image in three frequency ranges (low, medium, high). Adjust sharpness completely conform own preferences or use predefined preset.

11.6 Input D320 CVBS/S-Vid

11.6.1 Settings start up

How to start up

1. Click **Adjust** against CVBS/S-Vid input on the Input Slots part of the menu gives the CVBS/S-Vid parameter window. (image 11-7)
2. Click on the **Back** to return to the general D320 window.
3. Click on **Restore default settings** to restore the default settings.

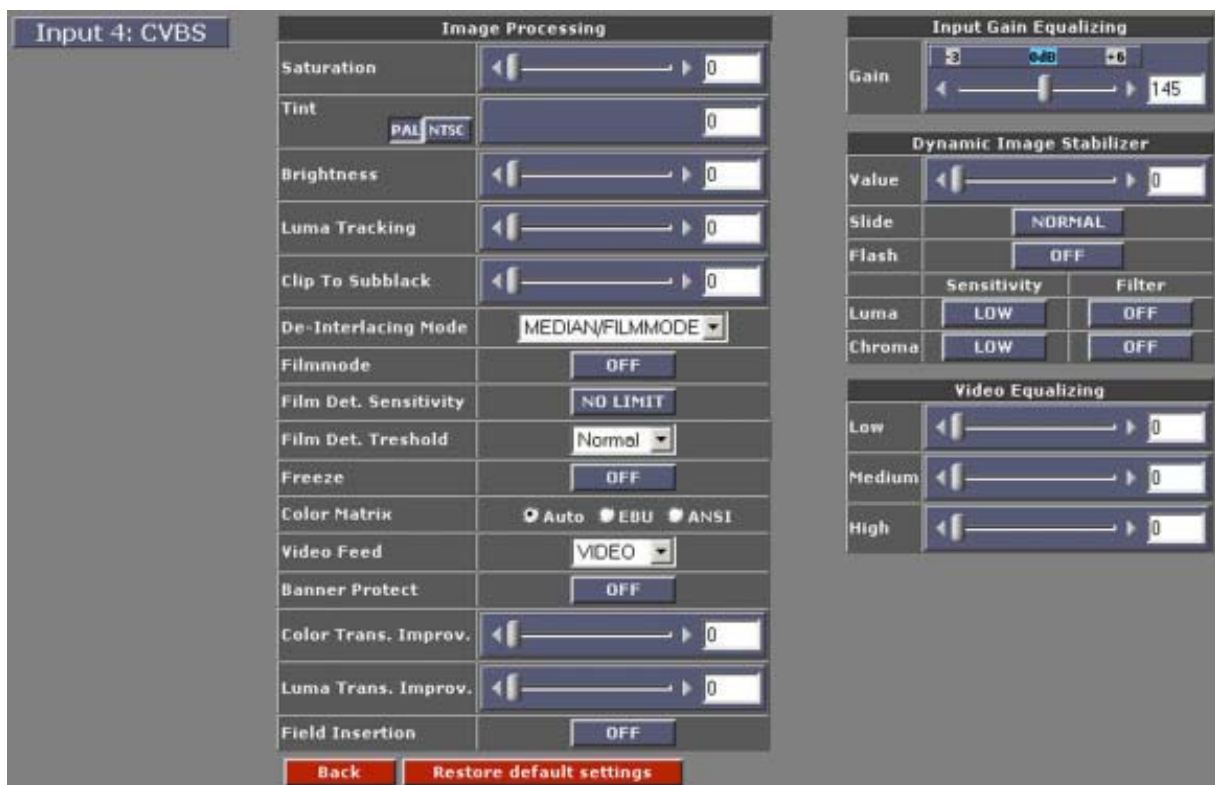

Image 11-7
Settings CVBS/S-Vid input slot D320

What can be adjusted?

This window consists out of 4 parts:

- Image processing
- Input gain equalizing
- Dynamic gain stabilizing
- Video Equalizing

11.6.2 Image Processing



CVBS

Composite Video Broadcast System. For D320 CVBS module, also S-Video and Composite Video available.

Saturation

Adjustable from 0 to 15 with the corresponding slider.

Saturation is the intensity of the color, 0 will be black & white.

Brightness

Adjustable from 0 to 63 with the corresponding slider.

Brightness is the intensity of the displayed signal.

Brightness will add or subtract ... to the luminance part of the signal.

Tint

If your input source is NTSC, click on **NTSC**. The slider will be available. If your source is Pal/Secam, click on **PAL**. The slide will disappear.

Adjustable from 0 to 255 with the corresponding slider.

Only for NTSC 4.43 or NTSC 3.58

Contrast

Adjustable from 0 to 127 with the corresponding slider.

Contrast is digital signal level alignment of the input signal.

Luma Tracking

Adjustable from 0 to 15 with the corresponding slider.

Luma Tracking adjusts the level of green haze appearing in the low lights.

Clip to Subblack

Adjustable from 0 to 15 with the corresponding slider.

Clip To Subblack will filter spurious LSB's in low lights under black-level, to prevent that spurious pixels appear in black planes, even after Dynamic Image Stabilization.

De-interlacing Mode

Select between Median/Filmmode or Line Repetition.

The *Median/Filmmode* is effective when the source signal has interlaced fields between frames.

The *Line Repetition* is effective for a non-interlace field sources (static images). The lines of the odd field will be doubled to obtain a complete image.

For normal video, Median/Filmmode should be selected.

Filmmode

Toggle between ON/OFF for either switching the Filmmode on or off.

Select ON to enable 2 to 2/3 to 2 pull down processing....

Select OFF to force the processing to normal ...



When filmmode is ON, banner protections is available.

Film Detection Sensitivity

Select the level at which the filtered response for film content should be driven at. Useful for noisy video content.

Film Detection Threshold

Select the level at which the film detection and processing is activated. Four levels exist. Useful for noisy video content.

Freeze

Freezes the content of this source only.

Color Matrix

Select a Color Matrix suitable for the material being viewed:

- AUTO Automatic adapted to incoming source, depending on measured raster frequency
- EBU European Standard (PAL/SECAM)
- ANSI American Standard (NTSC)

Video Feed

Two possible choices:

- Video
- S-Video

Select the input type which has to be displayed.

Banner Protect

Banner protect ON or OFF. Is only effective when Filmmode detection is in the ON position.

With banner protect ON, the bottom 1/4 of the lines will not be processed in Filmmode detection. That avoid scrolling banners or "ticker tapes" causing FILM mode errors.

Color Transient Improvement (CTI)

CTI sharpen the transient between two next to each other projected colors. The degree of improvement can be adjusted with the slider bar.

When on 0, the image is displayed without CTI. 7 represents the sharpest CTI.

Luma Transient Improvement (LTI)

LTI accentuates the transient between two parts of the image with different intensity. The degree of improvement can be adjusted with the slider bar.

When on 0, the image is displayed without LTI. 7 represents the sharpest LTI.

Field Insert

Field insert can be ON or OFF.

With *Field Insert* ON, both fields of a interlaced image will be added together to form one de-interlaced image.

When Field insert is ON, the De-Interlacing mode has no function.

11.6.3 Input Gain Equalizing

Overview

Each gain can be adjusted between 0 and 255 (-3dB and +6dB).

Any value can be entered by

- clicking first in digit box and entering the desired value or
- sliding the corresponding slider to the desired value.

11. Input Slots for ViewScape

3 values, -3dB, 0dB, +6dB or preprogrammed and can be selected by clicking on the corresponding indication.

The slider jumps immediately to the correct value.

The following input gain adjustments are possible:

- For S-Video
 - Luma gain
- For Video
 - Gain

11.6.4 Dynamic Image Stabilizer (DIS)

Value

between 0 and 7.

Slide

magnified/normal.

Magnified for DIS effectivity. Useful for noisy video content.

Flash

ON/OFF

To compensate for fast moving images, the DIS Flash will detect such movements and put the DIS temporary off.

DIS sensitivity

Select the amplitude sensitivity of the DIS

For low video quality sources choose Luma Low/ Chroma Low for video sources of high quality choose Luma High/ Chroma High (preferable)

DIS filter

Select the frequency sensitivity of the DIS

For low video quality sources choose Luma On/ Chroma On (preferable) for video sources of high quality choose Luma Off/ Chroma Off

11.6.5 Video Equalizing

Overview

Adjustment of the sharpness impression of the image in three frequency ranges (low, medium, high). Adjust sharpness completely conform own preferences or use predefined preset.

11.7 Input D320 RGB analog

11.7.1 Settings start up

How to start up

1. Click **Adjust** against RGB input on the Input Slots part of the menu gives the RGB parameter window. (image 11-8)
2. Click on the **Back** to return to the general D320 window.
3. Click on **Restore default settings** to restore the default settings.

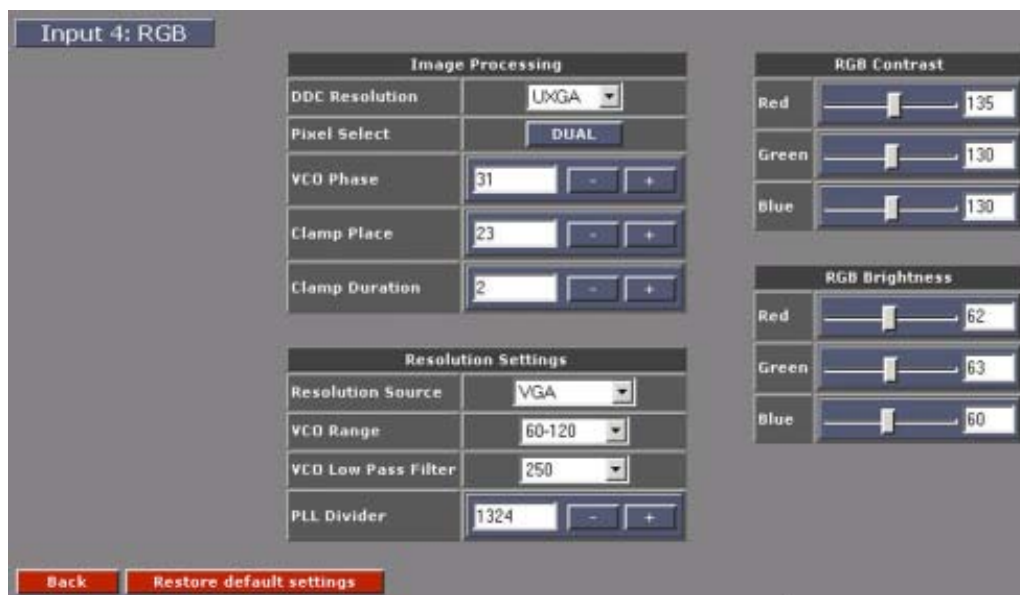

Image 11-8

What can be adjusted?

This window consists out of 4 parts:

- Image processing
- Resolution Settings
- RGB Contrast
- RGB Brightness

11.7.2 Image Processing

DDC Resolution

Configure the RGB input with VESA standard. There are five selectable resolution setup values that can be recognized by the graphic card through DDC communication.

VGA	85Hz refresh rate
SVGA	60Hz refresh rate
XGA	60Hz refresh rate
SXGA	60Hz refresh rate
SXGA	75Hz refresh rate

11. Input Slots for ViewScape

The graphic card will boot up in the selected display mode as far as the selected display mode is within the card's capabilities.

Clamp Place

To properly digitize the incoming signal, the dc offset of the input must be adjusted to fit the range of the A/D converter. Most Graphic systems produce RGB signals with black at ground and white at +0.75V. With this setting you can program the number of pixel times that should pass after the trailing edge of HSYNC before clamping starts.

Range 0 -255

Clamp Duration

This sets the duration of the clamp. These both adjustments, providing considerable flexibility, to have a good image

Range 0 - 255

11.7.3 Resolution Settings

Resolution Source

Set Resolution Source according the resolution of your source. When your graphic card has DCC communication, the resolution source setting should be the same as DDC resolution.

The following settings are possible:

VGA

SVGA

XGA

SXGA 60Hz

SXGA 75Hz

VCO Range

This setting will automatically set when the 'Resolution source' setting is entered.

15 - 30 MHz

30 - 60 MHz

60 - 120 MHz

110 - 140 MHz

VCO Low Pass Filter

Default value will be filled in. Change this value to a higher or lower value to improve the image.

50

100

150

250

350

500
750
1500

PLL Divider

Default value. Fine adjustment of the image possible by changing the value up or down. Change by one digit up or down and look to the result before changing more.

Changing the PLL divider, changes the horizontal sync value.

11.7.4 RGB Contrast

Changing the contrast

Utilize the sliders to determine a good color balance between Red, Green & Blue . Each has a range between 0 and 255

11.7.5 RGB Brightness

Changing the Brightness

Utilize the sliders to determine a good brightness between Red, Green & Blue. Each has a range between 0 and 126.

11.8 Input D320 RGB analog (UXGA)

11.8.1 Settings start up

How to start up

1. Click **Adjust** against RGB input on the Input Slots part of the menu gives the RGB parameter window. (image 11-9)
2. Click on the **Back** to return to the general D320 window.
3. Click on **Restore default settings** to restore the default settings.

11. Input Slots for ViewScope

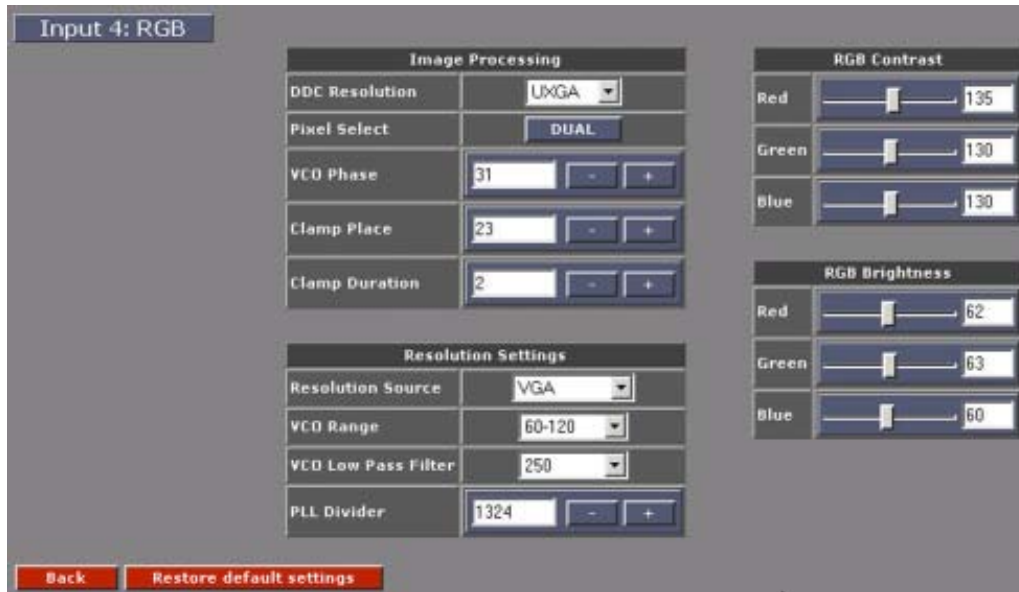

Image 11-9

What can be adjusted?

This window consists out of 4 parts:

- Image processing
- Resolution Settings
- RGB Contrast
- RGB Brightness

11.8.2 Image Processing

DDC Resolution

Configure the RGB input with VESA standard. There are five selectable resolution setup values that can be recognized by the graphic card through DDC communication.

VGA	85Hz refresh rate
SVGA	60Hz refresh rate
XGA	60Hz refresh rate
SXGA	60Hz refresh rate
SXGA	75Hz refresh rate
SXGA	85Hz refresh rate
UXGA	60Hz refresh rate

The graphic card will boot up in the selected display mode as far as the selected display mode is within the card's capabilities.

Clamp Place

To properly digitize the incoming signal, the dc offset of the input must be adjusted to fit the range of the A/D converter. Most Graphic systems produce RGB signals with black at ground and white at +0.75V. With this setting you can program the number of pixel times that should pass after the trailing edge of HSYNC before clamping starts.

Range 0 - 255

Clamp Duration

This sets the duration of the clamp. These both adjustments, providing considerable flexibility, to have a good image

Range 0 - 255

11.8.3 Resolution Settings

Resolution Source

Set Resolution Source according the resolution of your source. When your graphic card has DCC communication, the resolution source setting should be the same as DDC resolution.

The following settings are possible:

VGA

SVGA

XGA

SXGA 60Hz

SXGA 75Hz

SXGA 85Hz

UXGA 60Hz

VCO Range

This setting will automatically set when the 'Resolution source' setting is entered.

15 - 30 MHz

30 - 60 MHz

60 - 120 MHz

110 - 140 MHz

VCO Low Pass Filter

Default value will be filled in. Change this value to a higher or lower value to improve the image.

50

100

150

250

350

500

750

1500

PLL Divider

Default value. Fine adjustment of the image possible by changing the value up or down. Change by one digit up or down and look to the result before changing more.

Changing the PLL divider, changes the horizontal sync value.

11.8.4 RGB Contrast

Changing the contrast

Utilize the sliders to determine a good color balance between Red, Green & Blue . Each has a range between 0 and 255

11.8.5 RGB Brightness

Changing the Brightness

Utilize the sliders to determine a good brightness between Red, Green & Blue. Each has a range between 0 and 126.

GLOSSARY

Alpha Blending

Alpha Blending enables the ability to add transparency to any selected source.

Aspect ratio

horizontal & vertical dimension in which the window will be displayed, e.g. 4 by 3 or 16 by 9.

Color key

Sometimes also called chroma key. This is a method of combining two video images. An example of chroma keying in action is the nightly news person standing in front of a giant weather map. In actuality, the person is standing in front of a blue or green background and their image is mixed with a computer-generated weather map. This is how it works: a TV camera is pointed at the person and fed along with the image of the weather map into a box. Inside the box, a decision is made. Wherever it sees the blue or green background, it displays the weather map. Otherwise, it shows the person. So, whenever the person moves around, the box figures out where he is, and displays the appropriate image.

CVBS

Composite Video Broadcast System. For D320 CVBS module, also S-Video and Composite Video available.

DVI

Digital Visual Interface. DVI is a high speed serial display interface developed in response to the proliferation of digital flatpanel displays.

Overlap zone

The common area of 2 projector images next to each other. In this zone there will be soft edge blending, so that the combined screens will look like one big screen.

SDI

Serial Digital Interface

Slave direct

slave is directly connected to the previous digitizer by using the sync clock of the previous one.

Slave resync

slave is directly connected to the previous digitizer but the sync clock is restored.

Z-order

The layer sequence in which windows will be displayed in relation to one another.

INDEX

A

Alpha Blending 64
 Aspect ratio 52
 Autodetection 26
 Serial Numbers 26
 Autodetect page 45
 Start up 45
 Autodetection page 46
 RS232 46
 Serial numbers 46
 Start autodetection 46

C

Color key 62
 Configuration 39
 Load from disk 39
 Configuration Manager 73–75, 78
 Loading 78
 save as 75
 Saving 74
 start up 73
 Configuration wizard 13–14, 17, 19
 New configuration 14, 17, 19
 Based on the output requirements 17
 Based on the resolution 17
 Based on ViewScape devices 14
 Last saved file 19
 Set up paths 13
 Window 13

D

D320 Configuration 97–100, 102–106, 109, 111–118
 Input Slots 97–100, 102–106, 109, 111–117
 CVBS/S-Vid 109
 DVI 98
 DVI settings start up 98
 Dynamic Image Stabilizer 102
 Dynamic Image Stabilizer D320 CVBS/S-Vid 112
 Dynamic Image Stabilizer SDI 105
 Image Processing 100, 104
 Image Processing D320 CVBS/S-Vid 109
 Input Gain Equalizing 102
 Input Gain Equalizing D320 CVBS/S-Vid 111
 Refresh/update 97
 RGB analog 113
 RGB analog (UXGA) 115
 RGB Image processing 113, 116
 RGB Resolution settings 114, 117
 RGB settings start up 113, 115
 SDI 103
 SDI settings start up 103
 Video Equalizing D320 CVBS/S-Vid 112
 Video Equalizing D320 SDI 106
 Video Equalizing D320 YUV/RG(s)B 103

YUV/RG(s)B 99
 YUV/RG(s)B settings start up 99, 109
 Input Slots D320 99, 115, 118
 Image processing 99
 RGB Brightness 115, 118
 RGB Contrast 115, 118
 Digitizer configuration 91, 93
 Pattern generation 91, 93
 Activation 91
 Overview 91
 Set up 93
 Digitizer settings 85–86, 91, 94–96
 Black level 94, 96
 Activation 94
 Overview 94
 Pattern generation 91
 Soft Edge 94–95
 Activation 94
 Overview 94
 Settings 95
 Timings 85–86
 Advanced 86
 Preset 86
 Digitizer Settings 88, 90
 Display Interface 90
 Timings 90
 Sync Generator 88
 Timings 88
 Display selection 42

G

General Requirements 7
 System 7

I

Input Slots 97, 106–108
 HDSDI 106–108
 Dynamic Image Stabilizer 108
 HDSDI settings start up 106
 Image Processing 107
 Video Equalizing 108
 ViewScape 97
 Inputs 106
 D320 series 106
 HDSDI 106
 Installation 7
 Software 7
 Introduction 5
 General 5

M

Moving window 48

N

- New configuration 14–15, 17–18
 - Based on the output requirements 17–18
 - Set up 18
 - Based on the resolution 17
 - Based on ViewScape devices 14–15, 17
 - Getting started 14, 17
 - Set up 15

P

- Preferences 81–82
 - Purpose 81
 - Screen position 82
 - Start up 81
 - Window offset 82
- Preset configurations 67–70
 - Loading 68–70
 - Removing 70
 - saving 67

R

- RS232 43–44
 - Set up 43
 - Start up 43
 - Status 44
 - Quick change 44

S

- Scaling windows 49
- Select window 48
- Set up 15, 18–23, 27–29, 32, 34–38
 - Autodetection 23
 - Based on the output requirements 18
 - Based on ViewScape devices 15
 - Black Balance 34
 - Adjustment 34
 - Black level 36
 - Adjustment 36
 - Color 35
 - Equalization 35
 - Compare configurations 27
 - Configuration preview 22
 - Contrast 35
 - Equalization 35
 - Current configuration 19
 - Digitizer output 20
 - Final settings 37
 - Finish wizard 38
 - Gamma setup 34
 - Input Balance 34
 - Adjustment 34
 - Mechanical overlap 32
 - Output check 29
 - Soft edge blending 34
 - Update configuration 28
 - White Balance 34

- Adjustment 34
- Working windows 21–22
 - Definition 21
 - Removing 22
- Software 9
- Start up 9
- Start Autodetection 25
- Start up 9
- System configuration 76
 - Configuration Manager 76
 - deleting 76
- System Configuration 50
- Windowing 50
- Z-Order 50

V

- ViewPort 55–56, 58–60
 - Copy settings 60
 - Create for multiple background 58–59
 - Create for single source 56
 - Group changes 60
 - Overview 55
- ViewpPort 55
- ViewScape 11, 41, 83–85, 91, 94
 - Application 41
 - Overview 41
 - Close 11
 - Configuration 83–84
 - Settings 84
 - Start up 83
 - Digitizer settings 85, 91, 94
 - Black level 94
 - Pattern generation 91
 - Soft Edge 94
 - Timings 85
 - Output 85
 - Selection 85
 - Settings 84
 - Operational mode 84

W

- Window mode 53
 - Change 53
- Window name 52
 - Change 52
- Windowing 47–50, 52–56, 58–62, 64, 66–70
 - Alpha Blending 64
 - Aspect ratio 52
 - Color key 62
 - Display configuration 47
 - Full window 54
 - Group changes 50
 - Input configuration 47
 - Locking a window 54
 - Moving window 48
 - Preset configurations 67–70
 - Loading 68–70

- Removing 70
 - saving 67
- Scaling windows 49
- Select window 48
- Settings 66
- ViewPort 55–56, 58–60
 - Copy settings 60
 - Create for multiple background 58–59
 - Create for single source 56
 - Group changes 60
- Overview 55
- Visibility setup 61
- Window mode 53
 - Change 53
- Window name 52
 - Change 52
- Work Space Resolution 66
- Wizard 23
- RS232 Communication 23
 - Settings 23

LIST OF IMAGES

2-1	Set up choices	8
2-2	Internet options Settings	9
2-3	Starting the Service Launcher	9
2-4	Starting ViewScape Toolset	9
2-5	Start up of the wizard	10
2-6	Start up when configuration known	10
3-1	Create new configuration	15
3-2	New configuration based on ViewScape devices	15
3-3	Device setup	16
3-4	Resolution per screen	16
3-6	Set up overlap area	17
3-7	Design configuration based on requirements	17
3-8	Resolution definition window	18
3-9	Set up the image dimensions	18
3-10	Configuration selection	19
3-11	Starting from last file	19
3-12	Current configuration	20
3-13	Detailed current configuration	20
3-14	Projector input selection	20
3-15	Defining the wording windows	21
3-16	Show preview	22
3-17	Source connections to the ViewScape devices	22
3-18	Communication connections	23
3-19	RS232 communication settings	24
3-20	Offline message	24
3-21	Autodetection and log info view	25
3-23	Serial numbers on separate page	26
3-24	Serial numbers on Autodetect page	27
3-25	Compare result	27
3-26	Configuration message	28
3-27	Update wizard parameters to hardware	28
3-28	Update log window	29
3-29	Activate multiburst pattern	30
3-30	Update test pattern log window	30
3-31	Visual output check	30
3-32	Visual output check	31
3-33	Adjustment of Frequency	31
3-34	Adjustment of Phase	32
3-35	Update patterns	32
3-36	Log window special overlap patterns	33
3-37	Overlap zone adjustment	33
3-38	Overlap area adjustment	33
3-39	Updating gamma and soft edge blending	34
3-40	Update test pattern log window	35
3-41	Gamma setup	35
3-42	Apply bytelevel test pattern	35
3-43	Contrast and color equalization	36
3-44	Send blacklevel test pattern	36
3-45	Black level adjustment	36
3-46	Black level adjustment	37
3-47	Set Virtual coordinates	37
3-48	Wizard result window	38
3-49	Setting save	38
3-50	Save to file window	38
3-51	File download window	39
3-52	Select for the 'existing file' way	39
3-53	Load configuration window	40

4-1	The different window parts	41
4-2	Display selection	42
4-3	Apply level settings	42
5-1	RS232 Communication window	43
5-2	Status change RS232	44
6-1	Select Autodetection.....	45
6-2	Autodetection page	45
7-1	Window selection	48
7-2	Select window	48
7-3	Move window	48
7-4	Moving via the output box.....	49
7-5	Start Scaling window	49
7-6	Scaling the window	49
7-7	Scaling via the Output box	49
7-8	Group changes selected	50
7-9	Group changes.....	50
7-10	Z-order change.....	51
7-11	Z-order change.....	51
7-12	Select Z-order	51
7-13	Z-order selection	51
7-14	Changing the aspect ratio.....	52
7-15	Click on change name icon	53
7-16	Name change prompt window	53
7-17	Background message	54
7-18	Window lock	54
7-19	Full window selection	55
7-20	Full window settings	55
7-21	Select full size	55
7-22	Viewport set up for IE5.5 or lower	56
7-23	Viewport set up for IE6.0	56
7-24	View control selected	57
7-25	View control window	57
7-26	Resizing a viewport	57
7-27	Moving a viewport.....	57
7-28	Selecting default viewport.....	58
7-29	Default viewport settings will be loaded	58
7-30	Default viewport settings	58
7-31	Select viewport setup.....	58
7-32	Viewport window for Multiple 'independent' (hard edged) background.....	58
7-33	Viewport set up for multiple background	59
7-34	Viewport window for Multiple 'overlapped' background.....	59
7-35	Viewport for multiple 'overlapped' background	60
7-36	Select viewport group changes.....	60
7-37	Copy viewport settings	61
7-38	Select Visible	61
7-39	Zebra on a single color	62
7-40	Full color image	62
7-41	Result image after color keying.....	62
7-42	Color key window activation	63
7-43	Color key window status OFF	63
7-44	Color key window status ON.....	63
7-48	Alpha blending selection	65
7-49	Adjust settings source	66
7-50	Work space resolution.....	66
7-53	Preset configuration window.....	68
7-56	Info preset layout configuration.....	68
7-58	Preset info on mouse over	69
7-63	Keyboard representation	70
8-1	Control menu	73

8-2	Configuration manager page	73
8-3	Saving a configuration on the same name	75
8-4	Save OK	75
8-7	Select a configuration to delete.....	77
8-9	Delete message.....	77
9-1	Select Preferences.....	81
9-2	Preferences window	81
9-3	Window offset	82
9-4	Screen position.....	82
10-1	Configuration window ViewScope, digital or analog output selected	83
10-5	ViewScope configuration	84
10-6	ViewScope configuration with independent (hard edged) background.....	85
10-7	Selecting a preset timing	86
10-8	Advanced Timings menu	87
10-9	Sync generator timing window.....	87
10-10	Display Interface timings window.....	88
10-11	Explanation of the terms	89
10-13	Test pattern generator window	92
10-14	Pattern choices.....	93
10-15	Start up soft edge & black level	94
10-16	Soft Edge settings and black level adjustment.....	94
11-3	Setting DVI input slot D320	98
11-4	Settings YUV/RG(s)B input slot D320	100
11-5	Settings SDI input slot D320.....	103
11-6	Setting HDSDI input slot for D320 series.....	106
11-7	Settings CVBS/S-Vid input slot D320.....	109

Revision Sheet

To:

► **Barco nv Events/Documentation**

Noordlaan 5, B-8520 Kuurne

Phone: +32 56.36.89.70, Fax: +32 56.36.88.24

E-mail: antoon.dejaegher@barco.com, Web: www.barco.com

From: _____

Date: _____

Please correct the following points in this documentation (**R5976476/03**):

page	wrong	correct